

BASIC

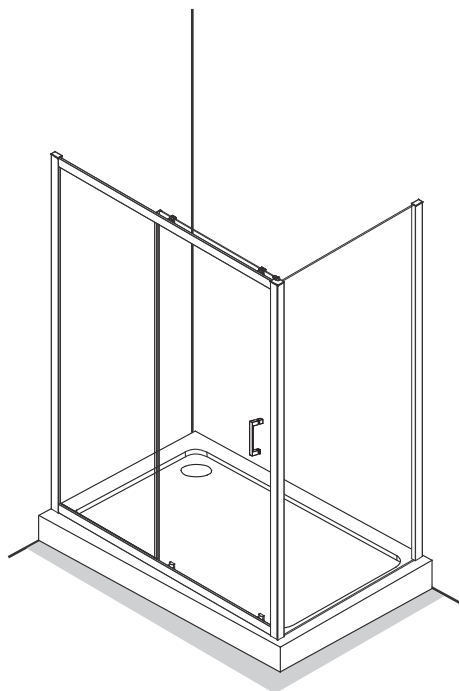

PL INSTRUKCJA MONTAŻU I EKSPLOATACJI

CZ NÁVOD NA MONTÁŽ A ÚDRŽBU

SK NÁVOD NA MONTÁŽ A ÚDRŽBU

EST PAIGALDUS- JA KASUTUSJUHEND

LT MONTAVIMO IR EKSPLOATAVIMO INSTRUKCIJA

LV MONTĀŽAS UN EKSPLUATĀCIJAS INSTRUKCIJA

DE MONTAGE- UND AUFBAUANLEITUNG

RO INSTRUCȚIUNI DE MONTAJ ȘI OPERARE

HU SZERELÉSI ÉS ÜZEMELTETÉSI ÚTMUTATÓ

UA ІНСТРУКЦІЯ З МОНТАЖУ І ЕКСПЛУАТАЦІЇ

BY ІНСТРУКЦЫЯ ПА МАНТАЖЫ І ЭКСПЛУАТАЦЫИ

RU ИНСТРУКЦИЯ ПО МОНТАЖУ И ЭКСПЛУАТАЦИИ

EN INSTRUCTIONS FOR ASSEMBLY AND USE

FR INSTALLATION ET UTILISATION - MODE

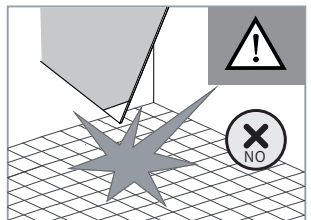
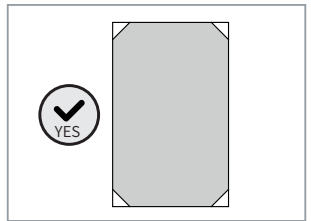
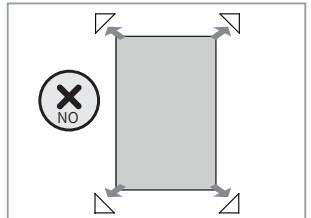
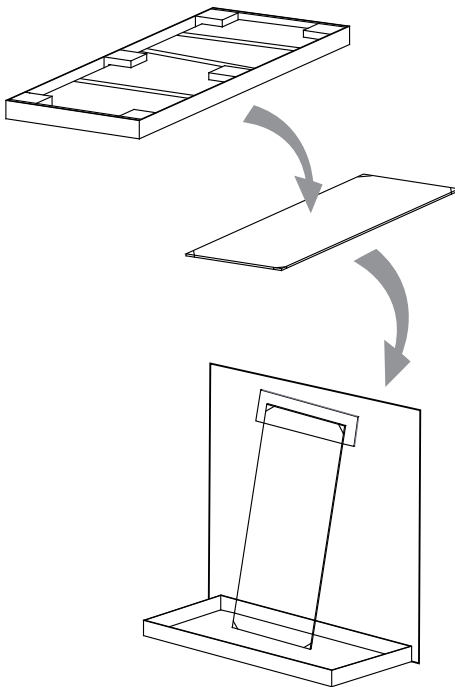
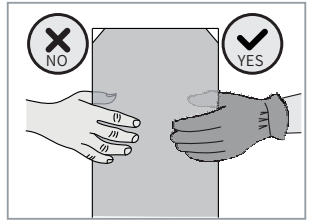
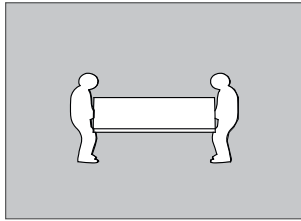
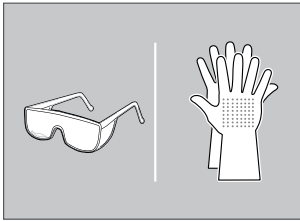
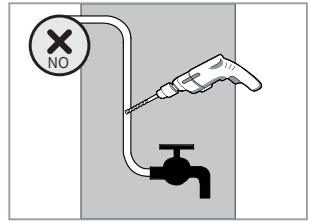
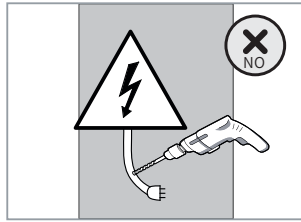
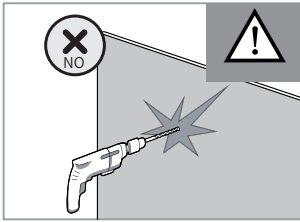

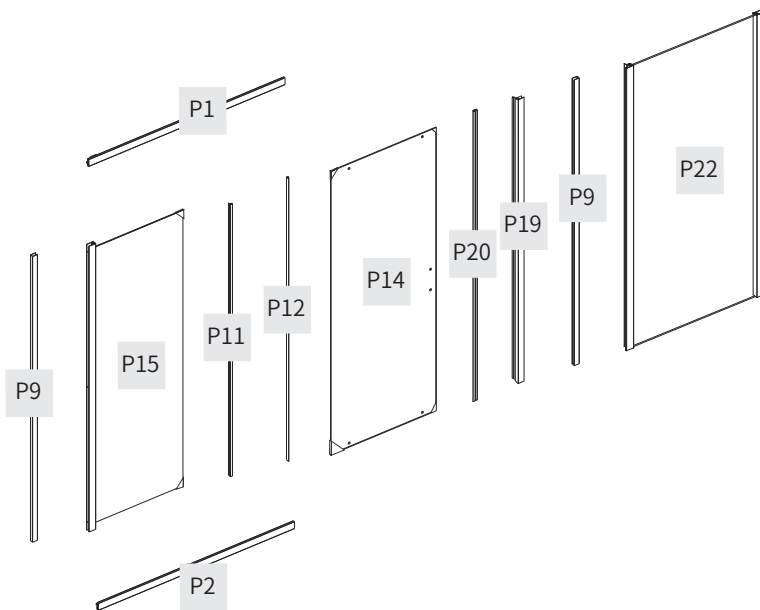

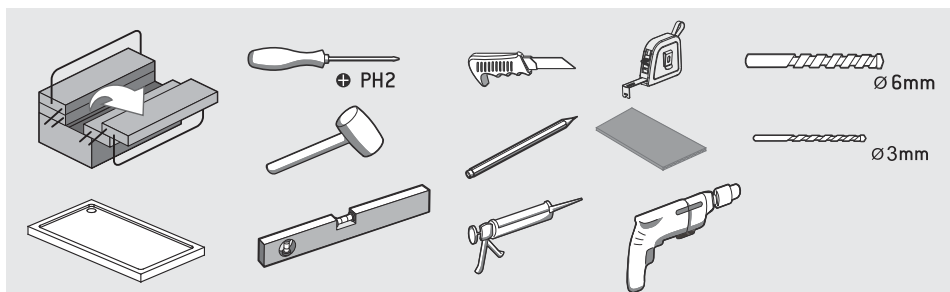
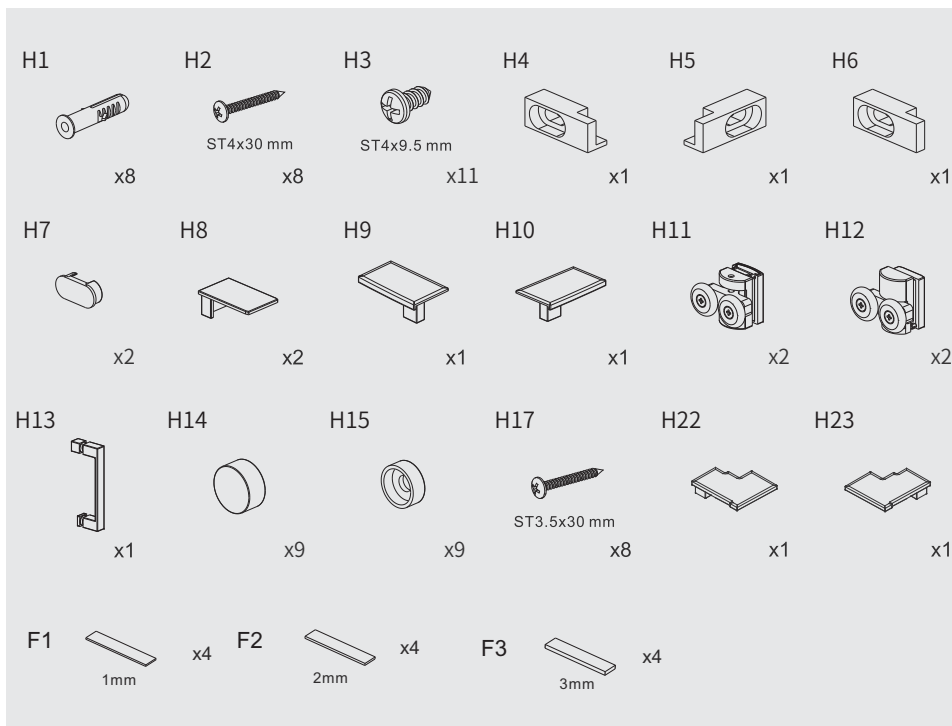

1.

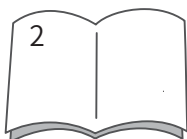
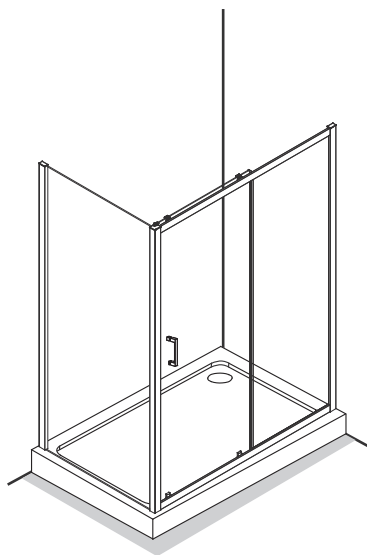
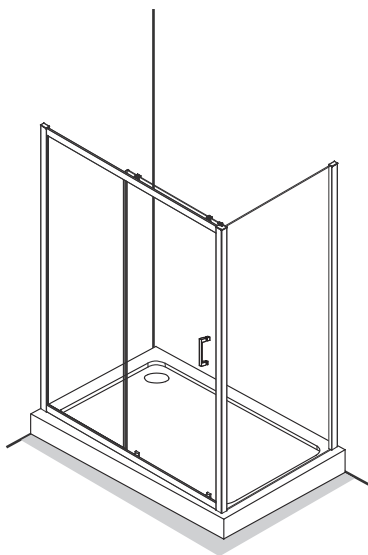

2.

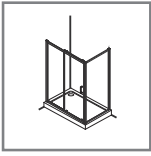

SIZE	X(mm)	Y(mm)
800x1000x1950	783-798	983-998
900x1200x1950	883-898	1183-1198

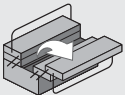
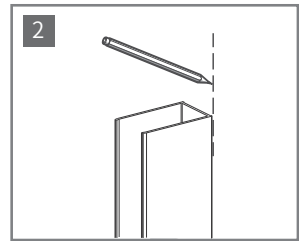
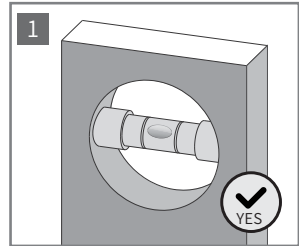
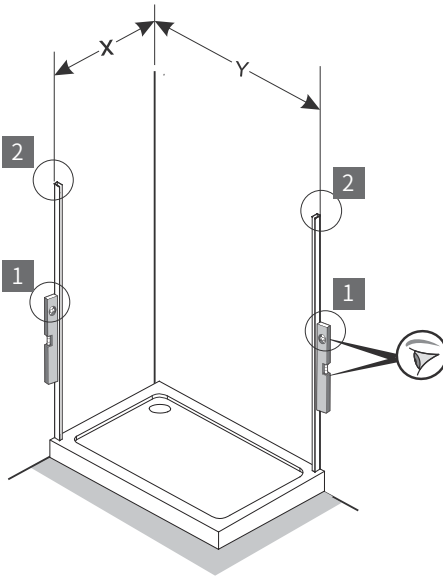

P9



x2



3.

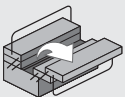
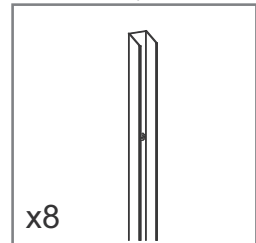
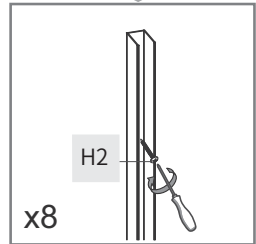
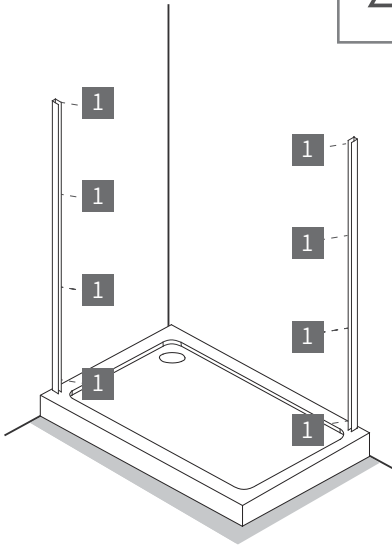
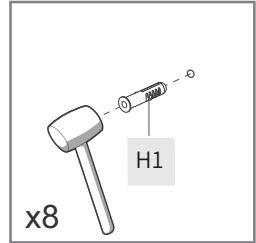
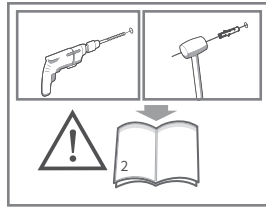
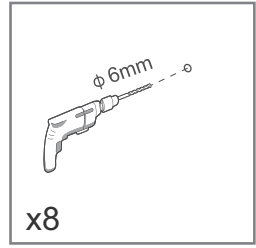
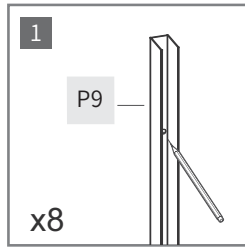
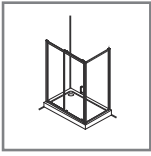

H1



x8



H2



x8

⊕ PH2



4.

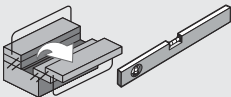
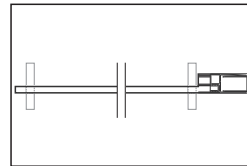
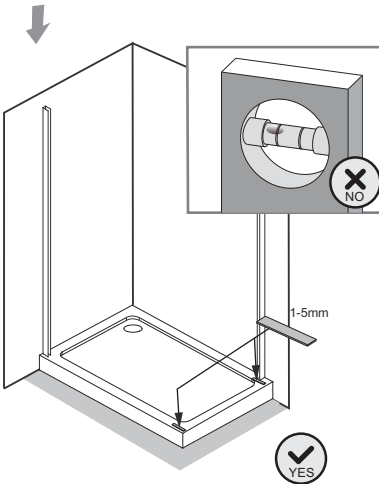
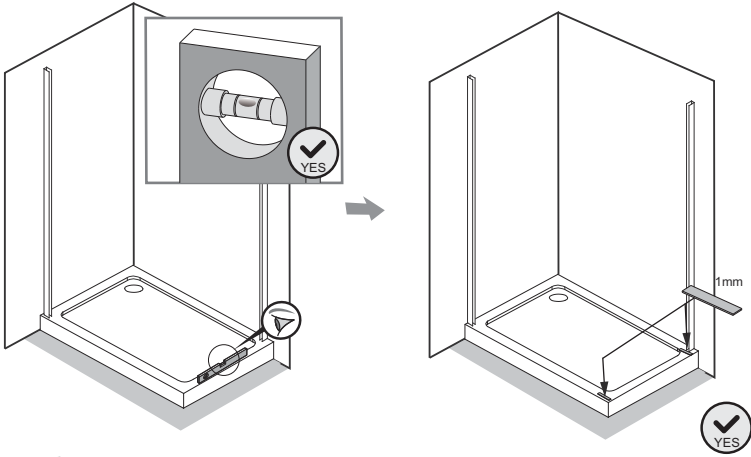
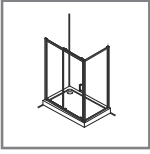

F1



1mm

x4

F2



2mm

x4

F3



3mm

x4



5.

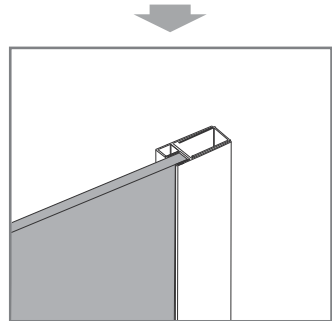
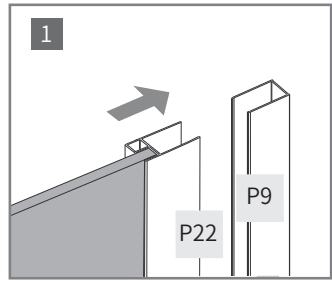
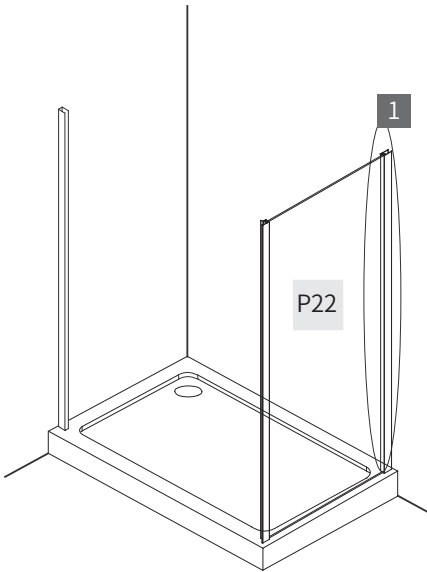
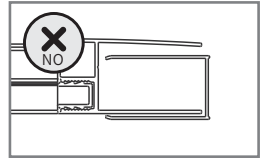
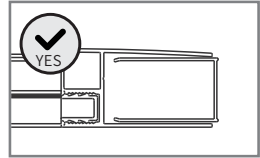
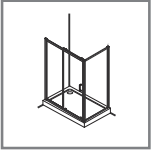

P22

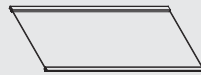

x1

P9





x1

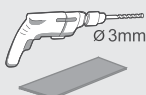
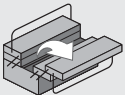
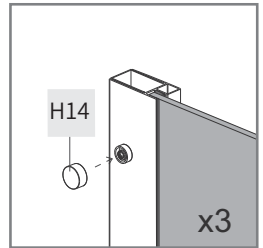
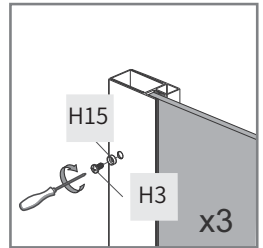
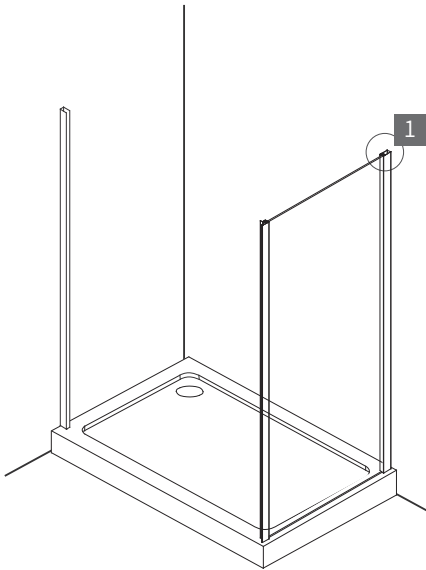
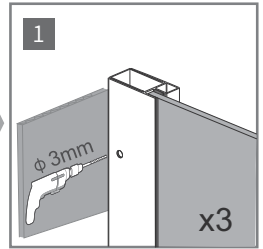
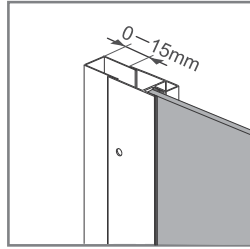
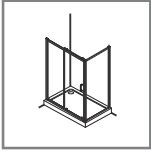

6.



H3  x3

H14  x3

H15  x3



7.

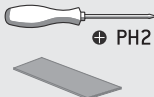
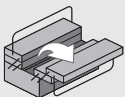
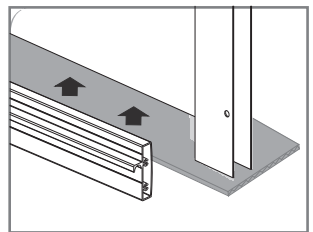
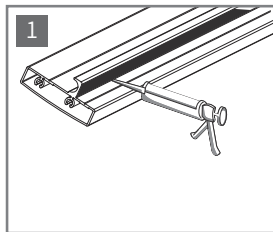
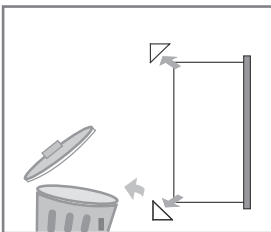
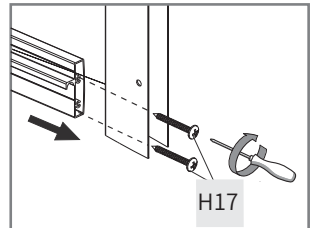
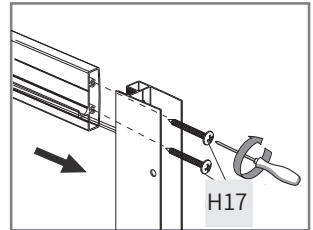
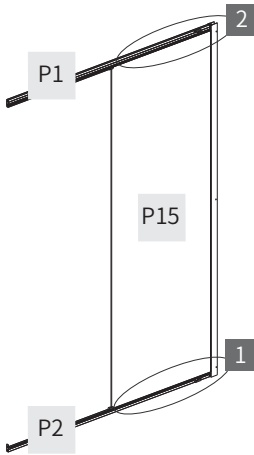
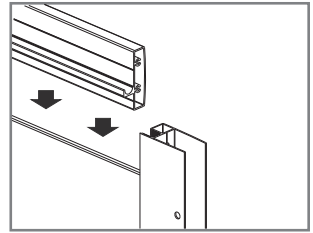
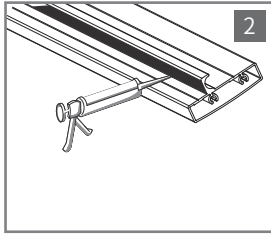
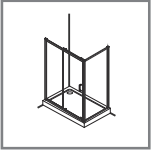

H17



x4



8.

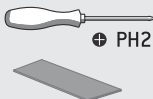
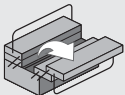
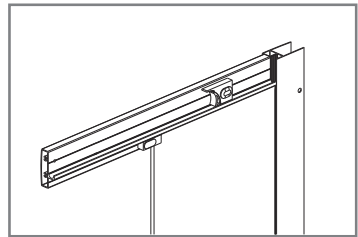
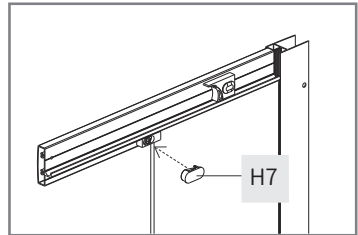
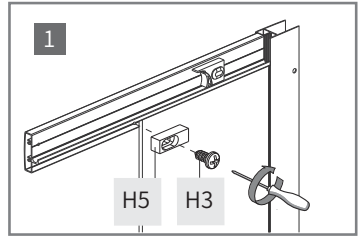
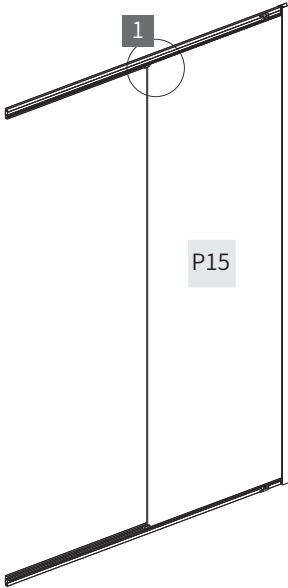
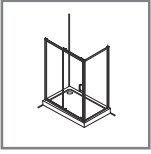

H3

H5

H7



x1



x1



x1



9.

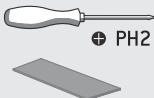
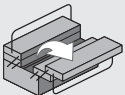
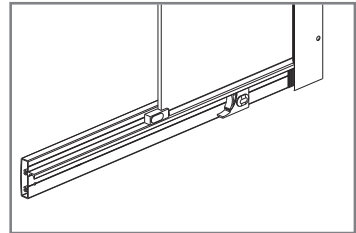
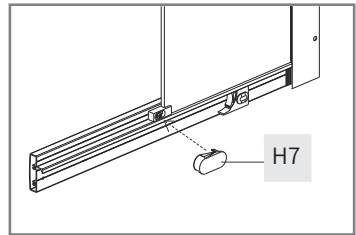
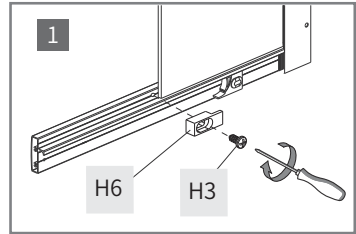
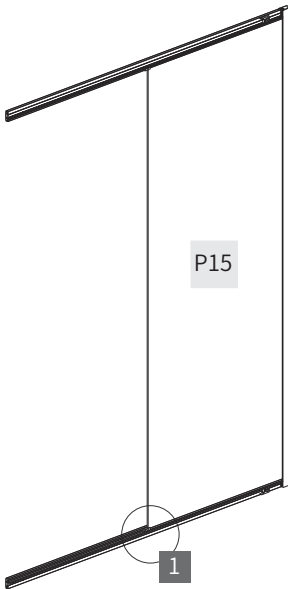
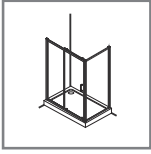

H3



x1

H6



x1

H7



x1



10.

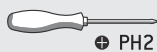
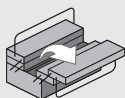
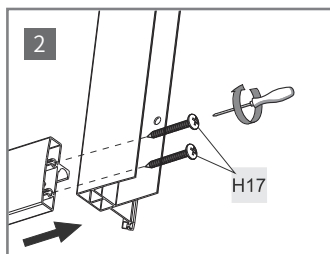
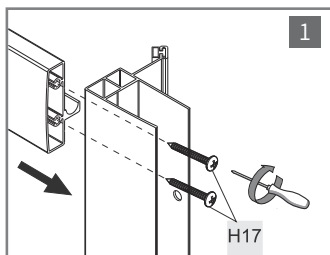
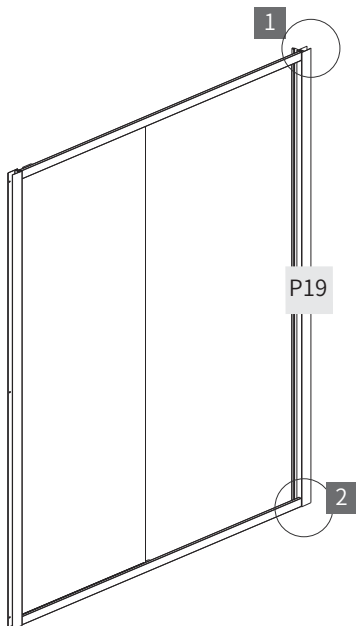
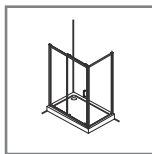

H17



x4



11.

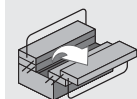
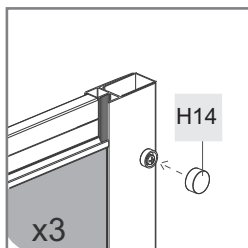
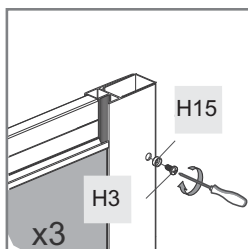
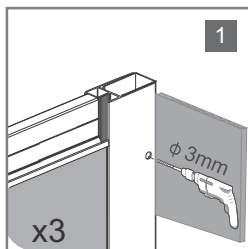
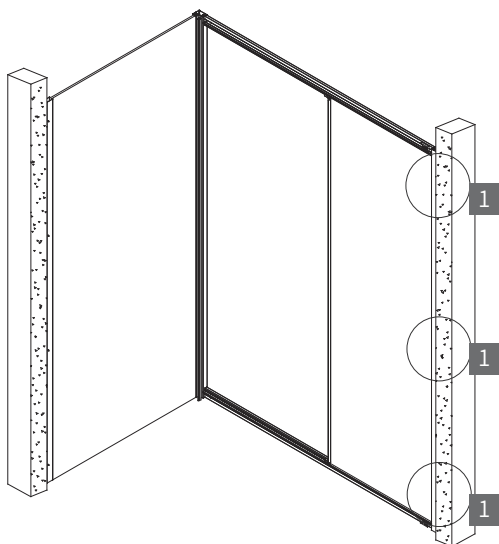
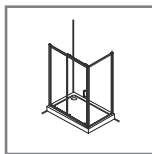

H3  x3

H14  x3

H15  x3

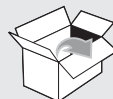

12.

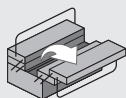
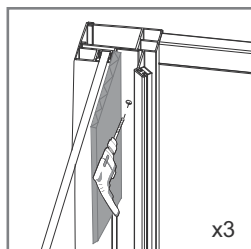
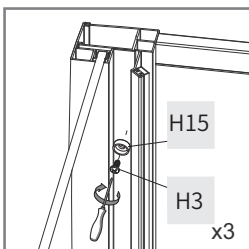
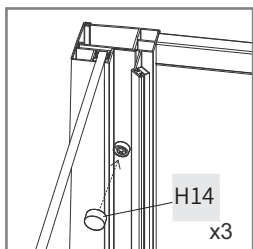
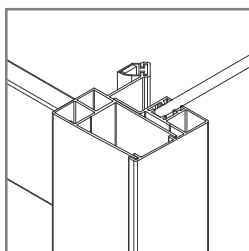
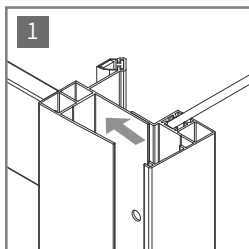
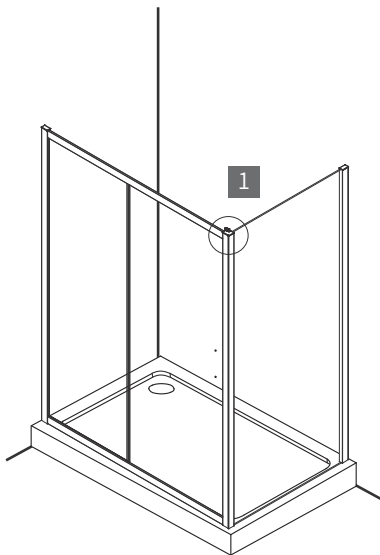
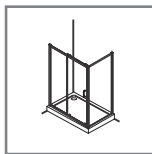

H3  x3

H14  x3

H15  x3



13.

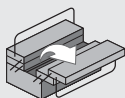
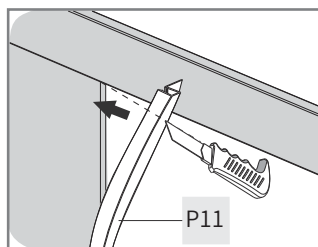
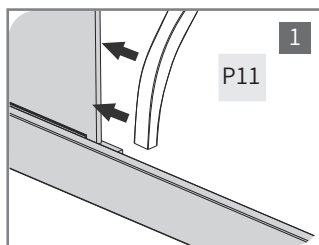
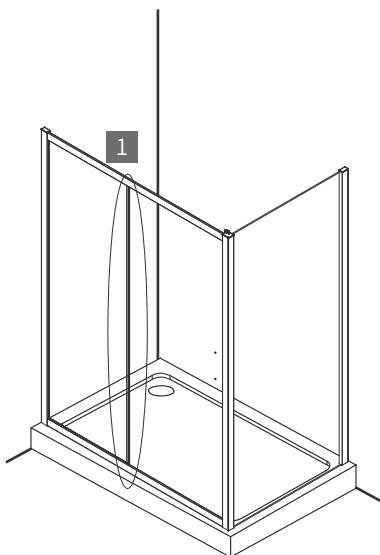
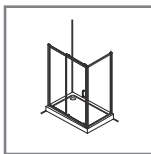

P11



x1



14.

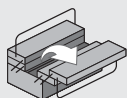
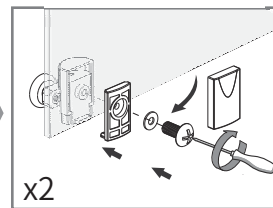
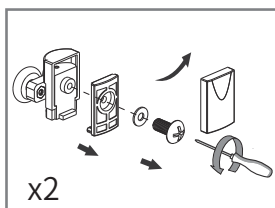
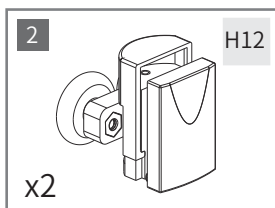
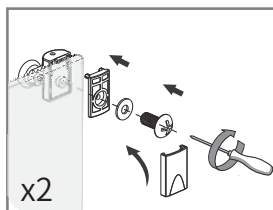
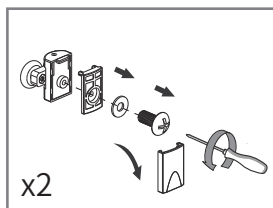
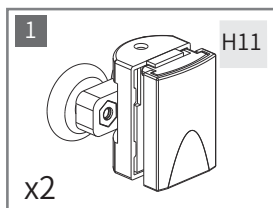
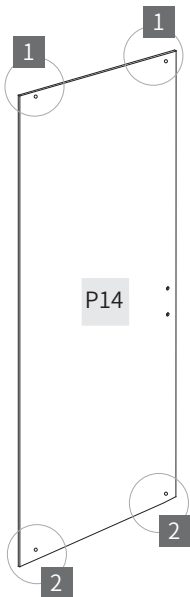
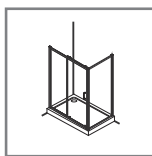

H12 x2

H11 x2



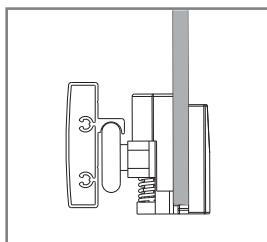
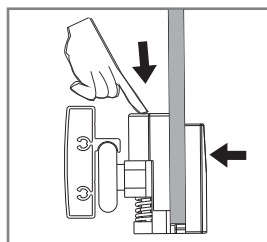
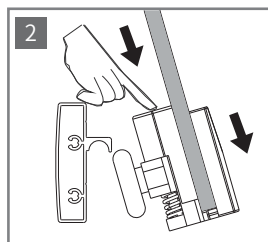
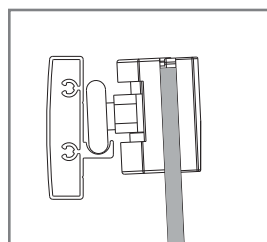
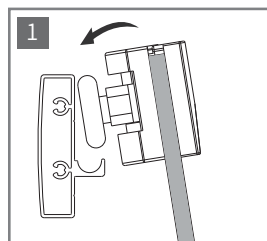
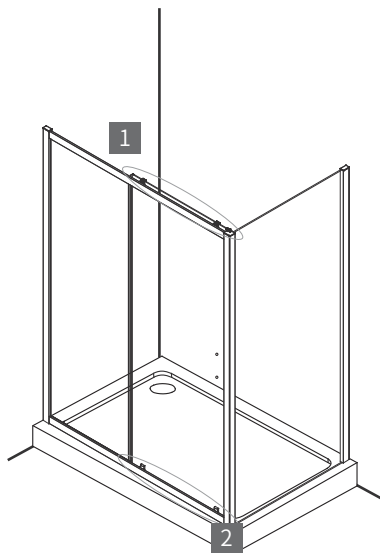
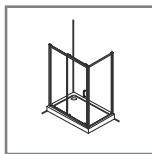

16.

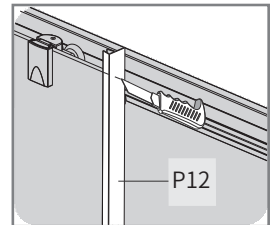
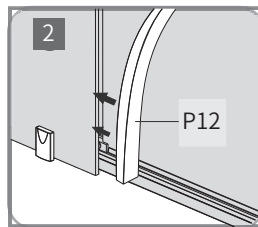
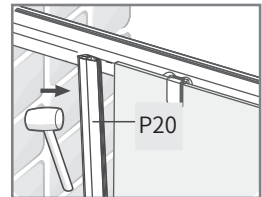
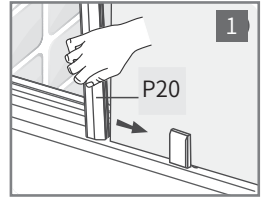
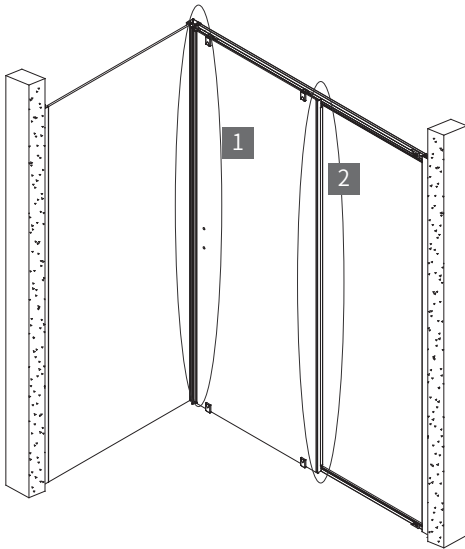
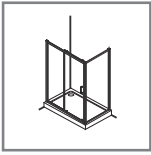

		P20		x1	
	P12		x1		



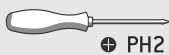
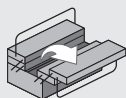
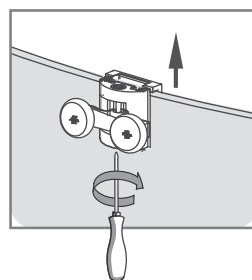
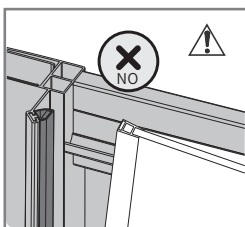
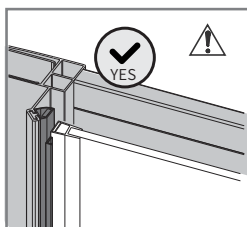
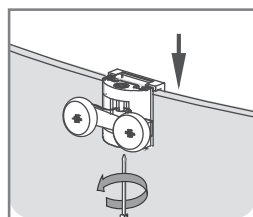
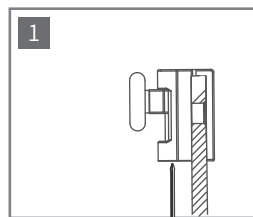
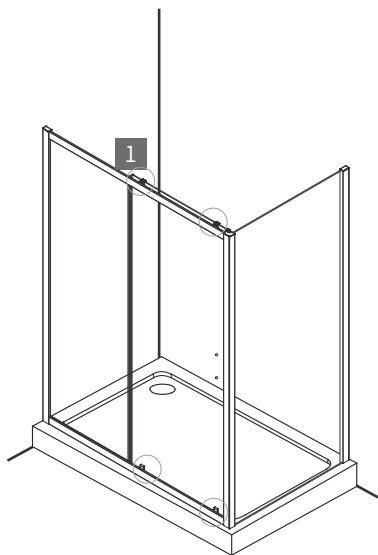
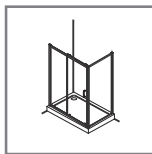



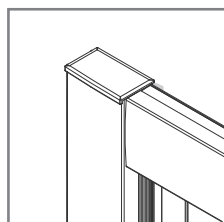
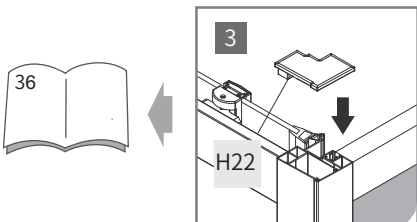
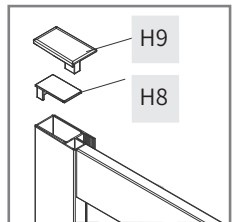
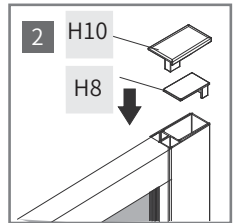
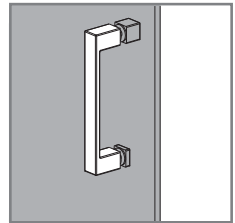
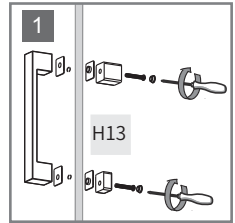
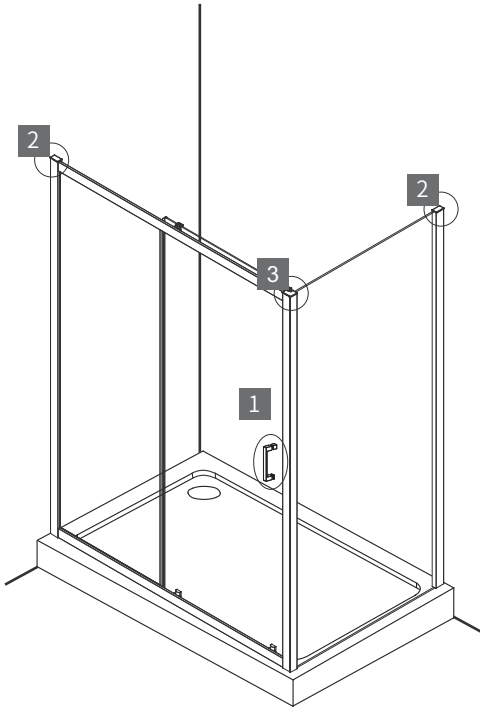
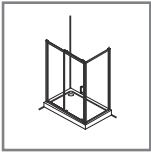

17.

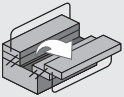

⊕ PH2

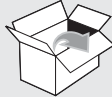
18.



		H8		x2	H22		x1	
		H9		x1	H13		x1	
		H10		x1				

19.

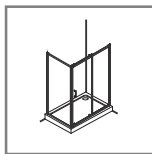

SIZE	X(mm)	Y(mm)
800x1000x1950	783-798	983-998
900x1200x1950	883-898	1183-1198

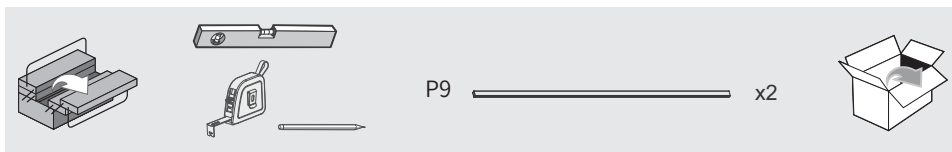
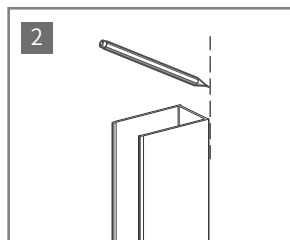
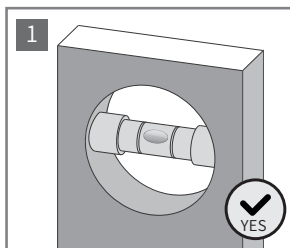
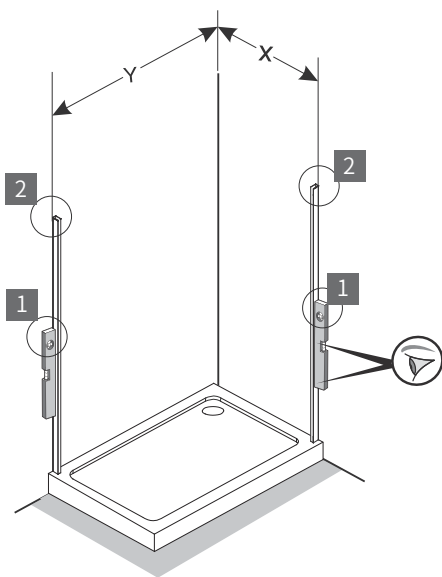

20.

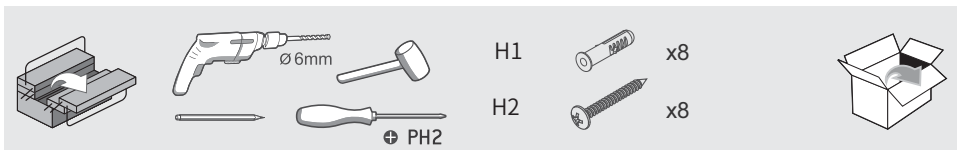
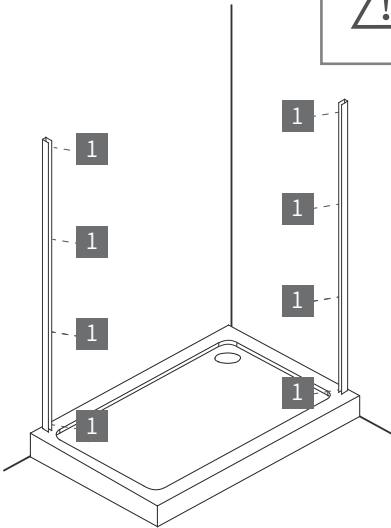
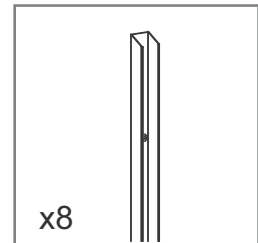
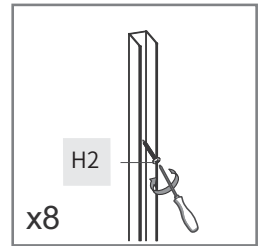
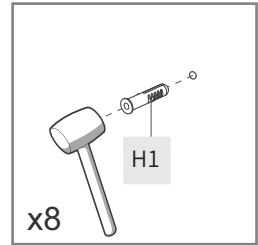
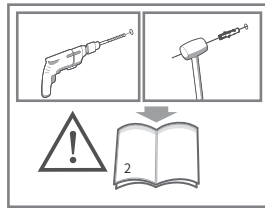
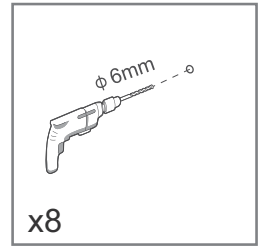
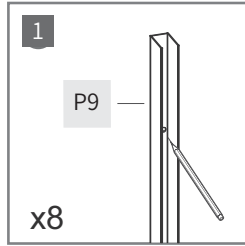
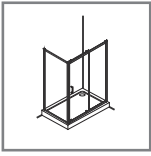

21.

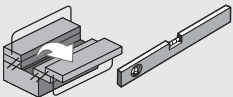
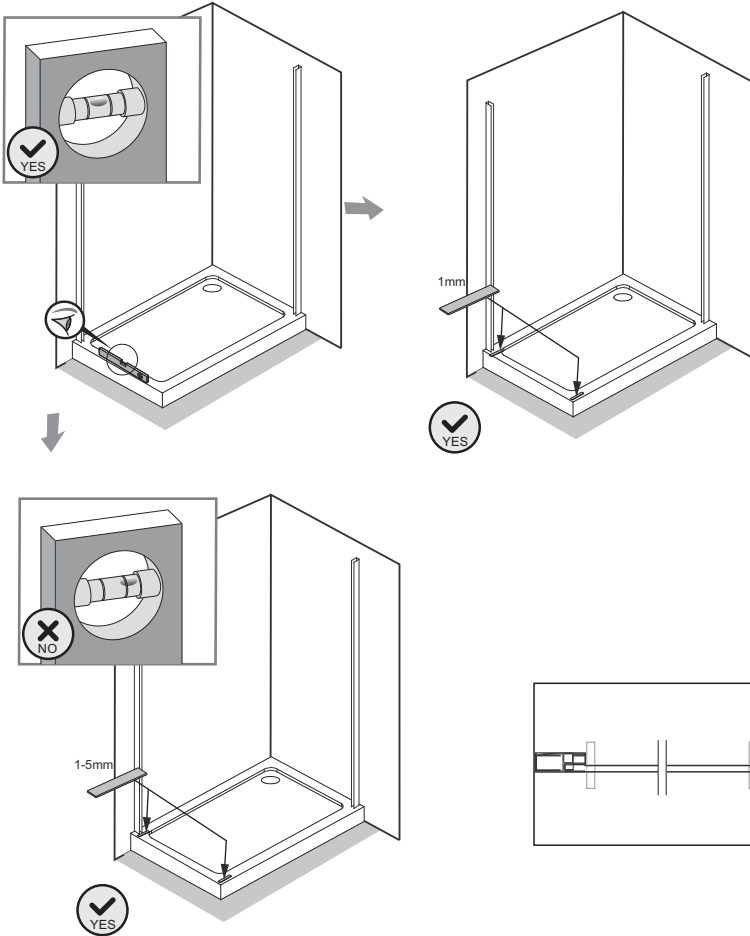
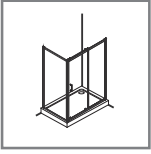

F1



1mm

x4

F2



2mm

x4

F3



3mm

x4



22.

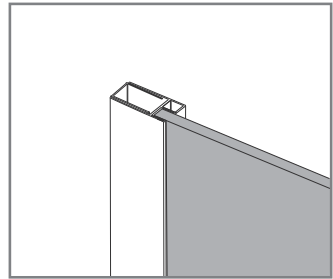
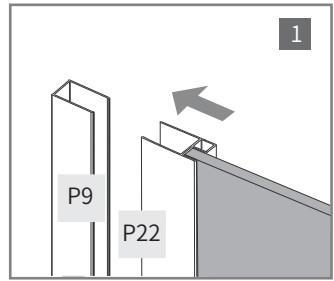
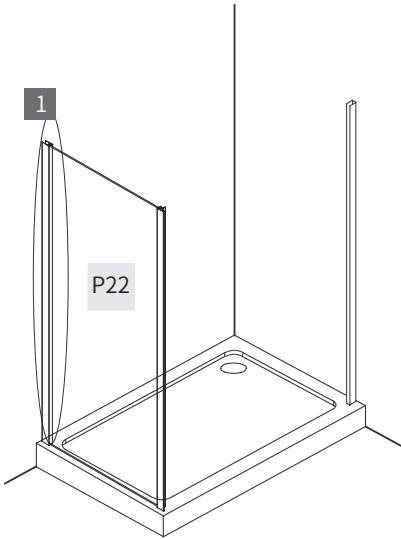
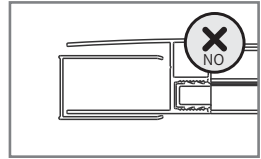
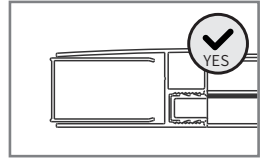
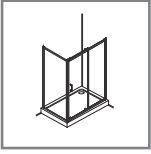

P22

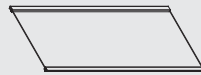

x1

P9







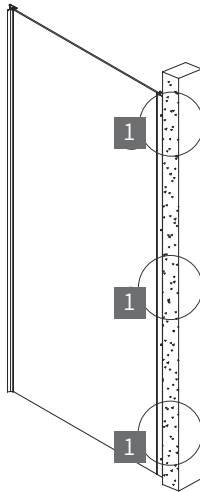
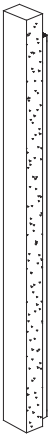
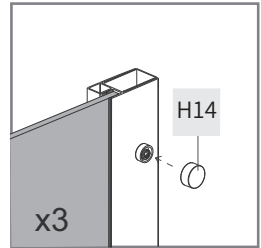
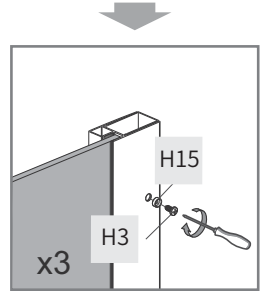
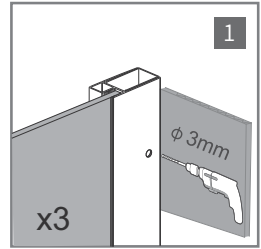
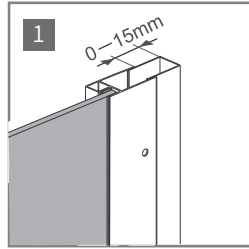
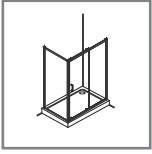

x1

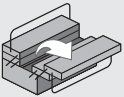
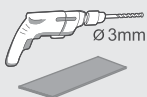

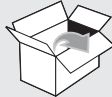
23.



			H3		x3	
			H14		x3	
			H15		x3	

24.

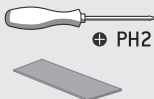
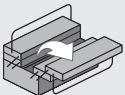
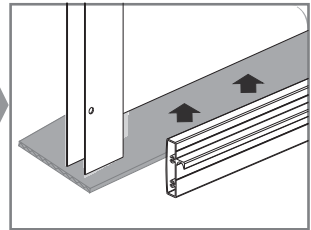
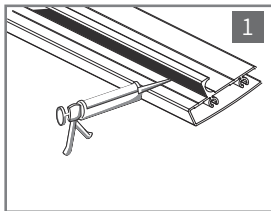
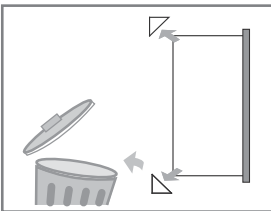
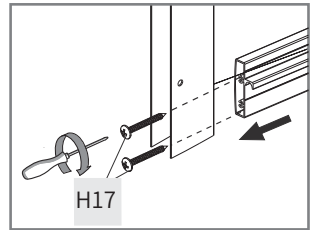
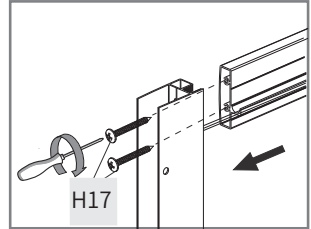
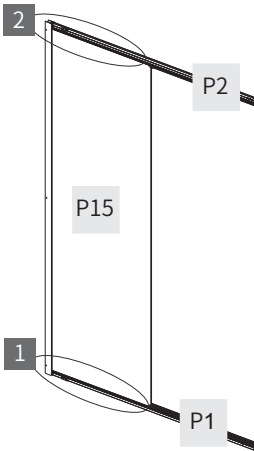
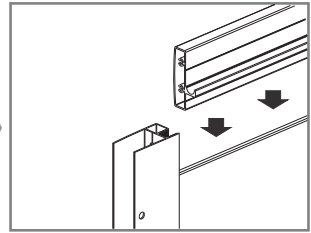
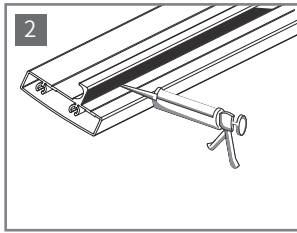
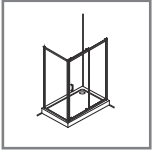

PH2

H17



x4



25.

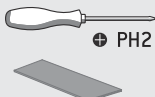
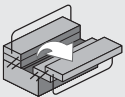
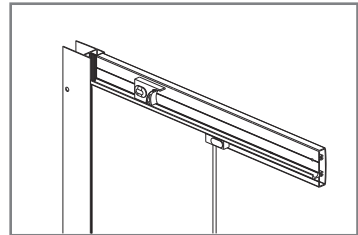
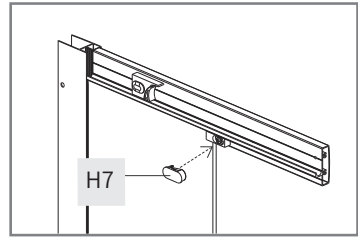
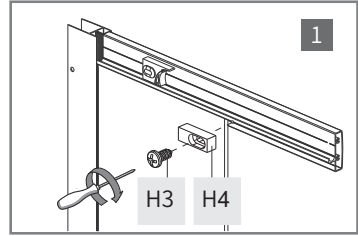
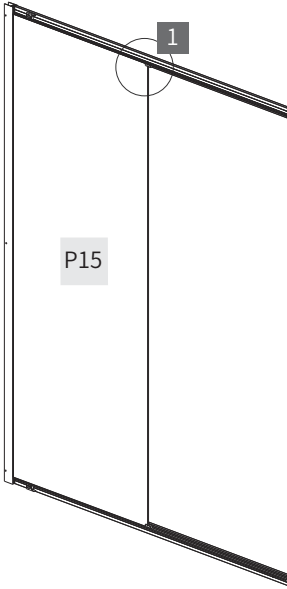
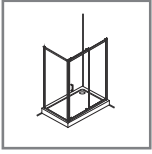

H3



x1

H4



x1

H7



x1



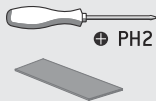
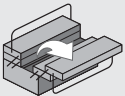
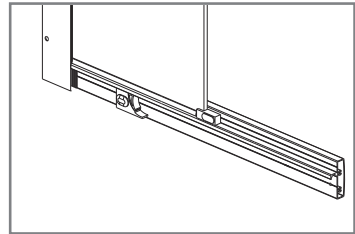
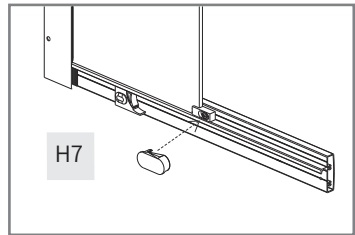
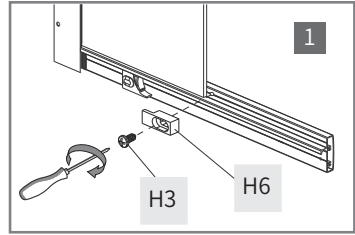
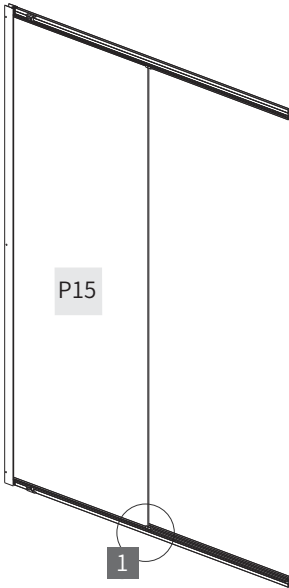
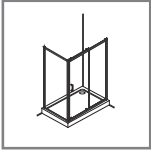

H3



x1

H6



x1

H7



x1



27.

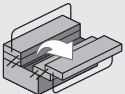
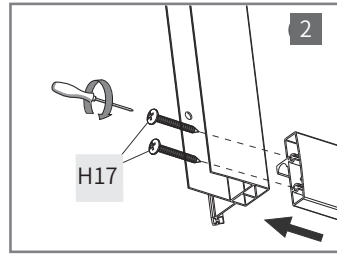
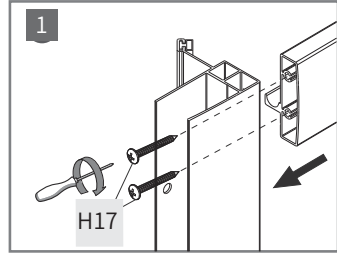
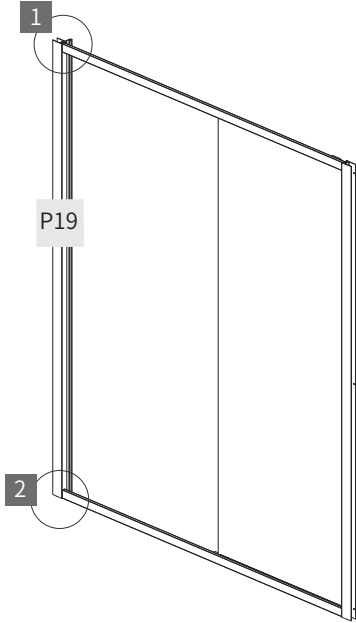
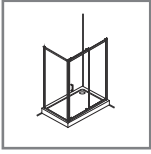

H17



×4



28.

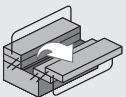
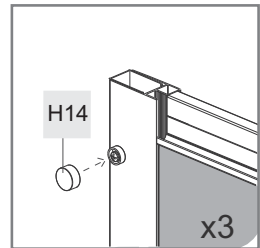
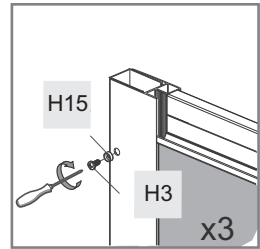
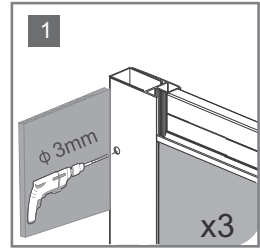
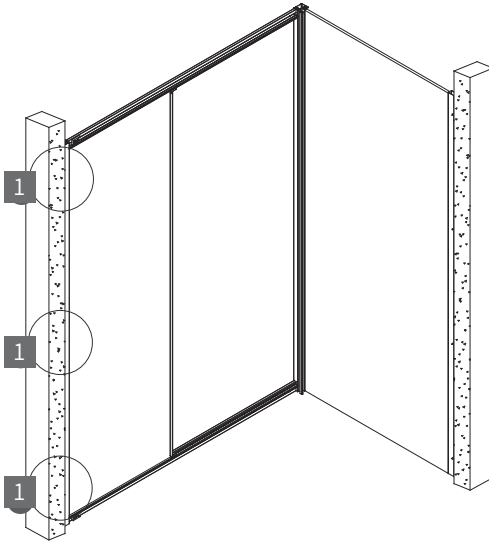
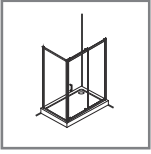

⊕ PH2

H3  x3

H14  x3

H15  x3



29.

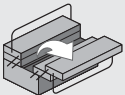
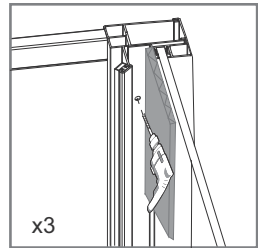
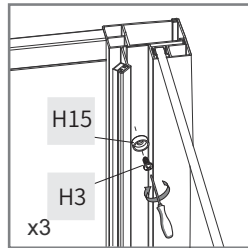
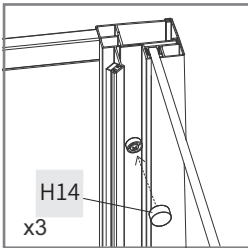
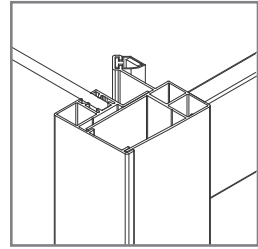
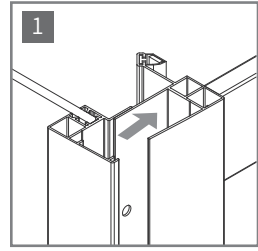
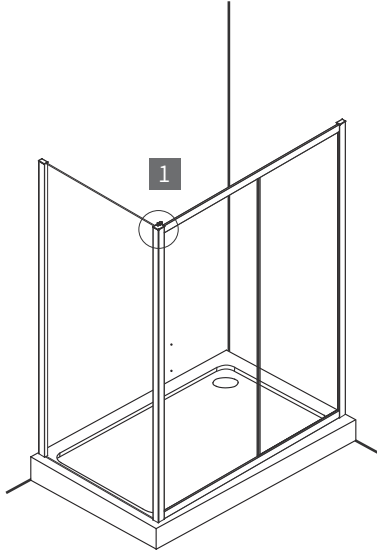
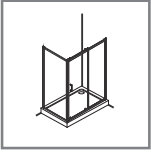

Ø6mm



PH2

H3 x3

H14 x3

H15 x3



30.

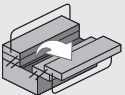
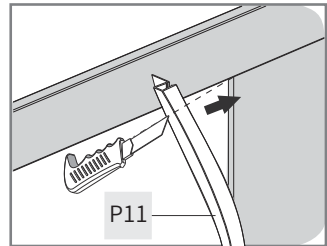
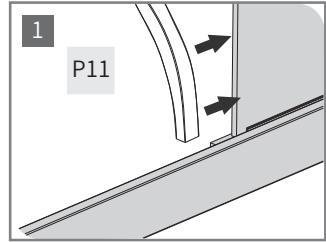
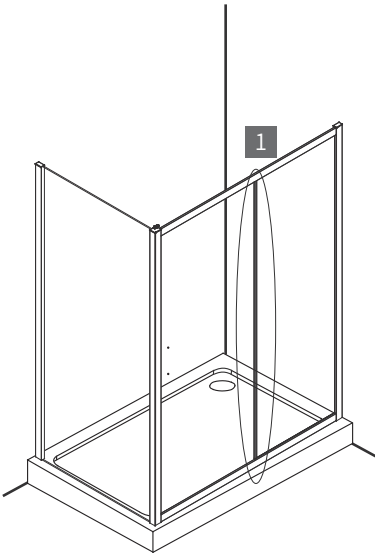
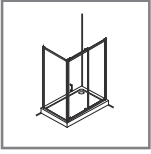

P11

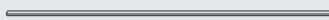

x1



31.

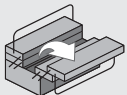
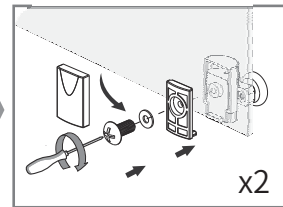
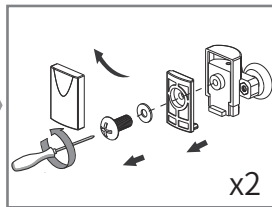
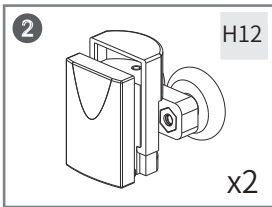
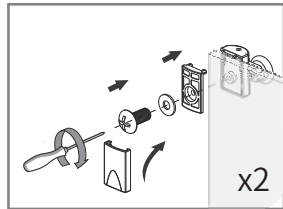
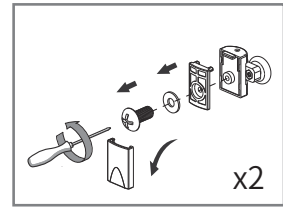
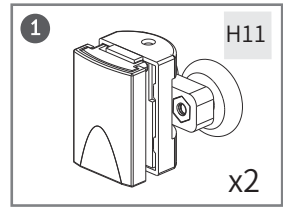
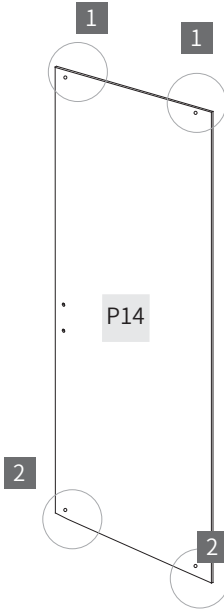
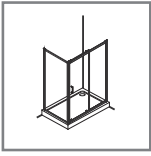

H12 x2

H11 x2



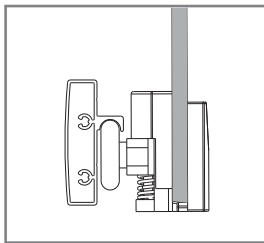
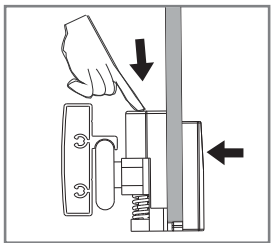
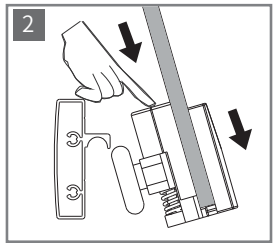
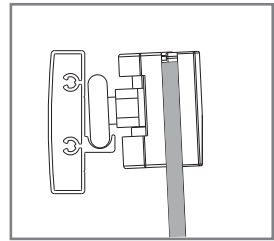
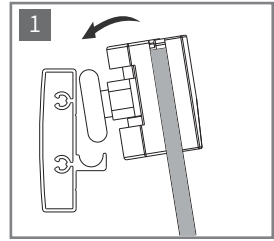
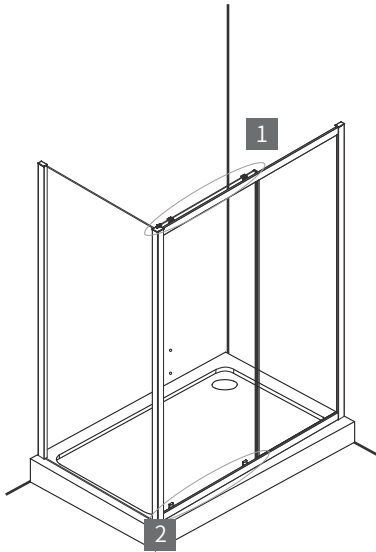
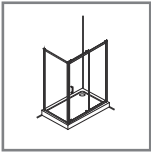

33.

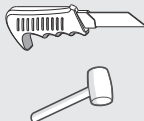
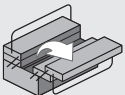
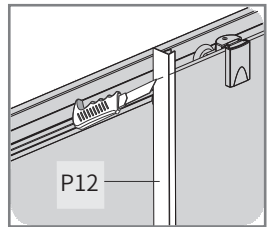
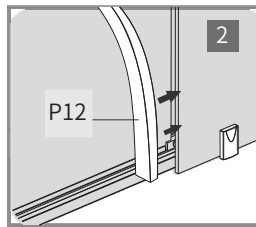
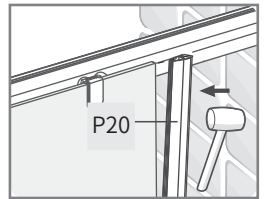
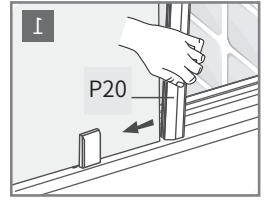
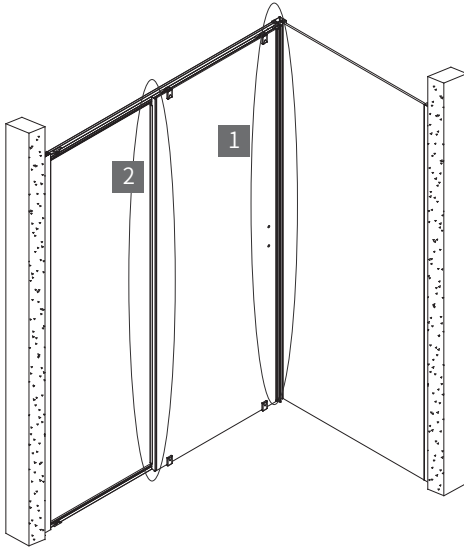
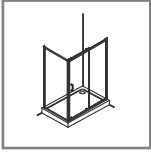

P20 ————— x1

P12 ————— x1



34.

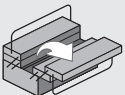
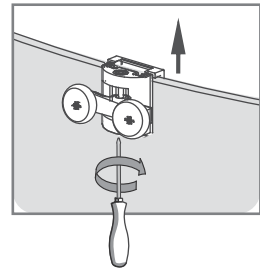
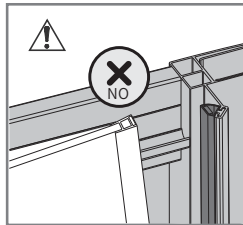
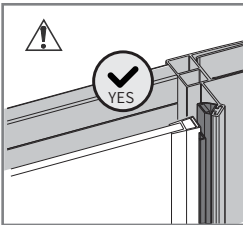
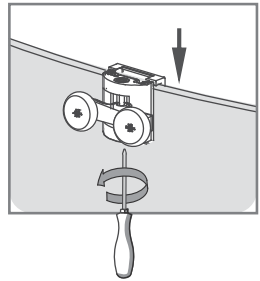
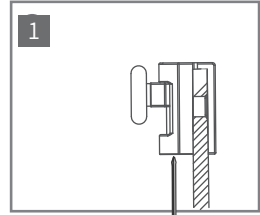
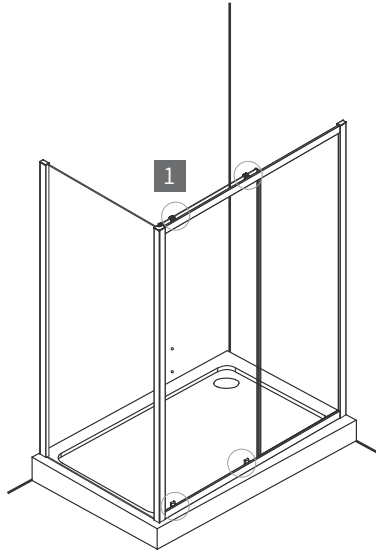
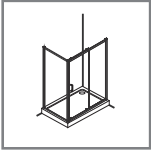

⊕ PH2

35.

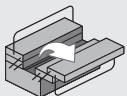
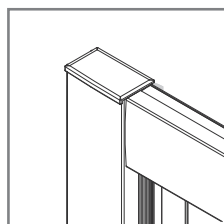
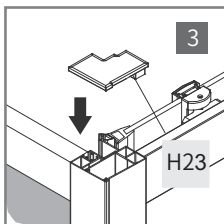
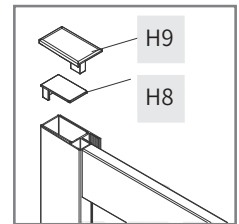
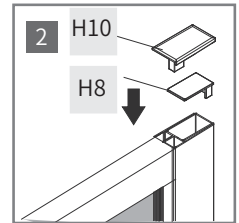
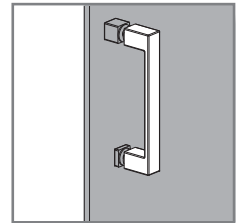
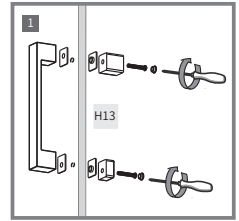
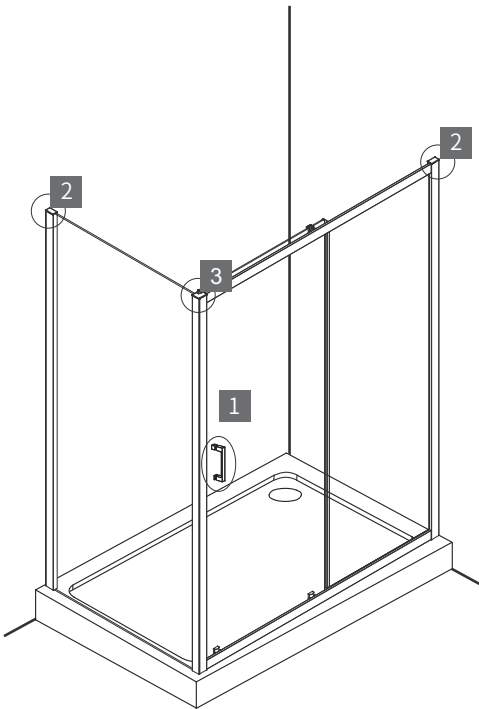
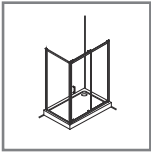

- | | | | | | |
|-----|--|----|-----|--|----|
| H8 | | x2 | H23 | | x1 |
| H9 | | x1 | H13 | | x1 |
| H10 | | x1 | | | |



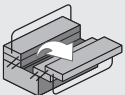
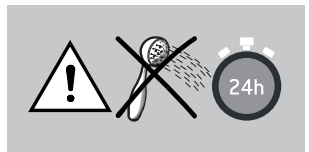
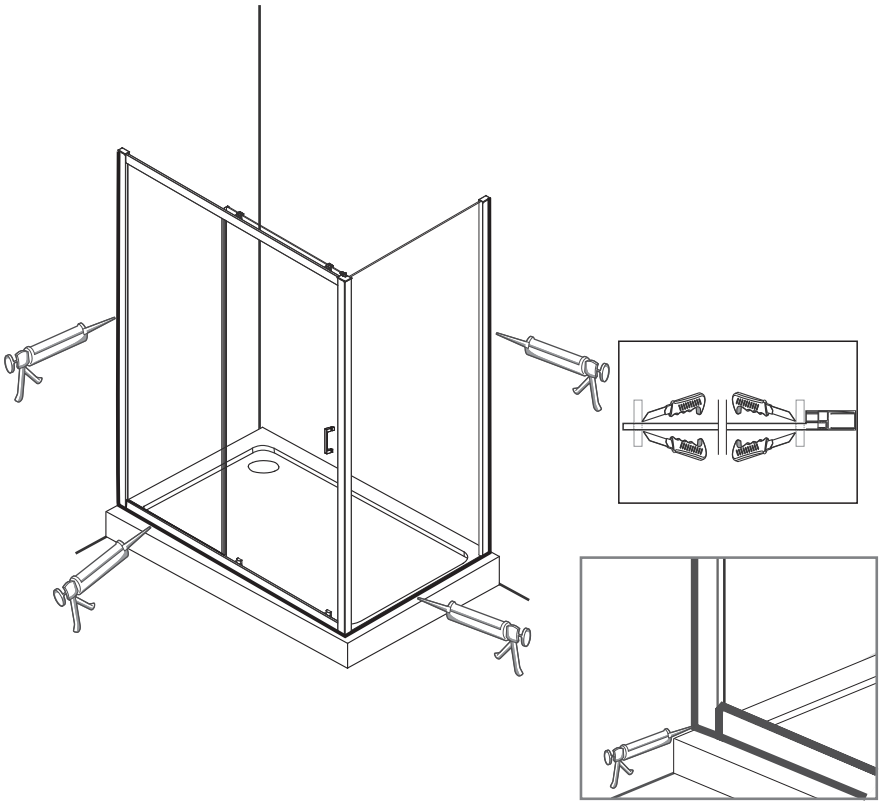



6.5<PH<7.5

