

BASIC

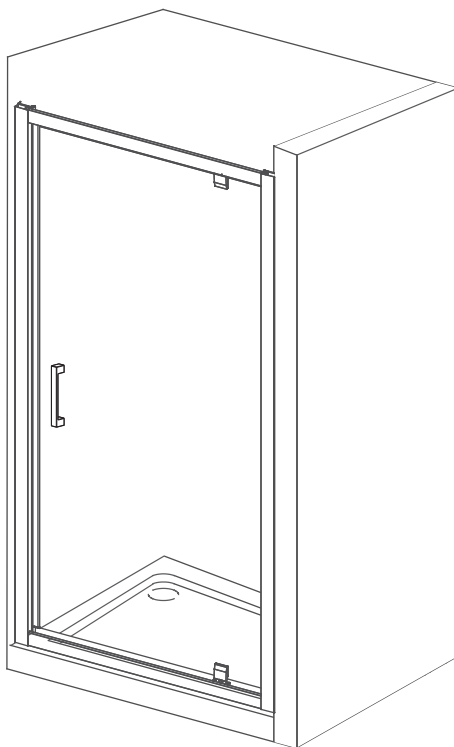

PL INSTRUKCJA MONTAŻU I EKSPLOATACJI

CZ NÁVOD NA MONTÁŽ A ÚDRŽBU

SK NÁVOD NA MONTÁŽ A ÚDRŽBU

EST PAIGALDUS- JA KASUTUSJUHEND

LT MONTAVIMO IR EKSPLOATAVIMO INSTRUKCIJA

LV MONTĀŽAS UN EKSPLUATĀCIJAS INSTRUKCIJA

DE MONTAGE- UND AUFBAUANLEITUNG

RO INSTRUCȚIUNI DE MONTAJ ȘI OPERARE

HU SZERELÉSI ÉS ÜZEMELTETÉSI ÚTMUTATÓ

UA ІНСТРУКЦІЯ З МОНТАЖУ І ЕКСПЛУАТАЦІЇ

BY ІНСТРУКЦЫЯ ПА МАНТАЖЫ І ЭКСПЛУАТАЦЫІ

RU ИНСТРУКЦИЯ ПО МОНТАЖУ И ЭКСПЛУАТАЦИИ

EN INSTRUCTIONS FOR ASSEMBLY AND USE

FR INSTALLATION ET UTILISATION - MODE

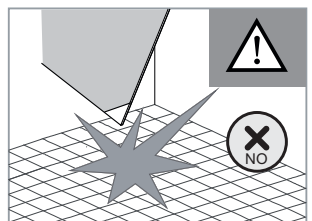
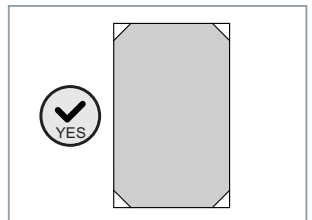
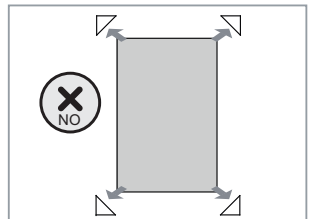
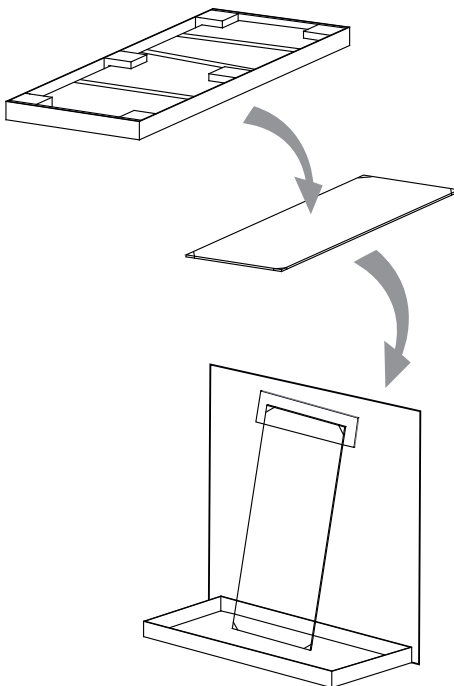
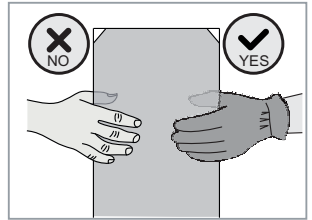
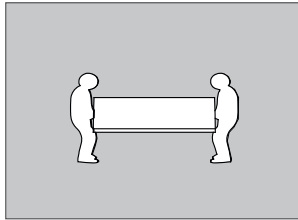
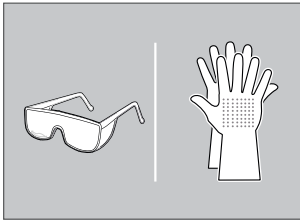
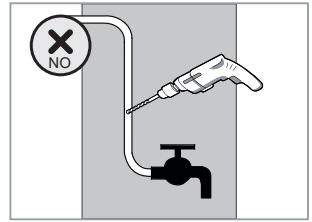
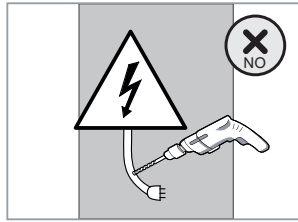
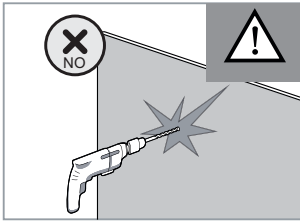

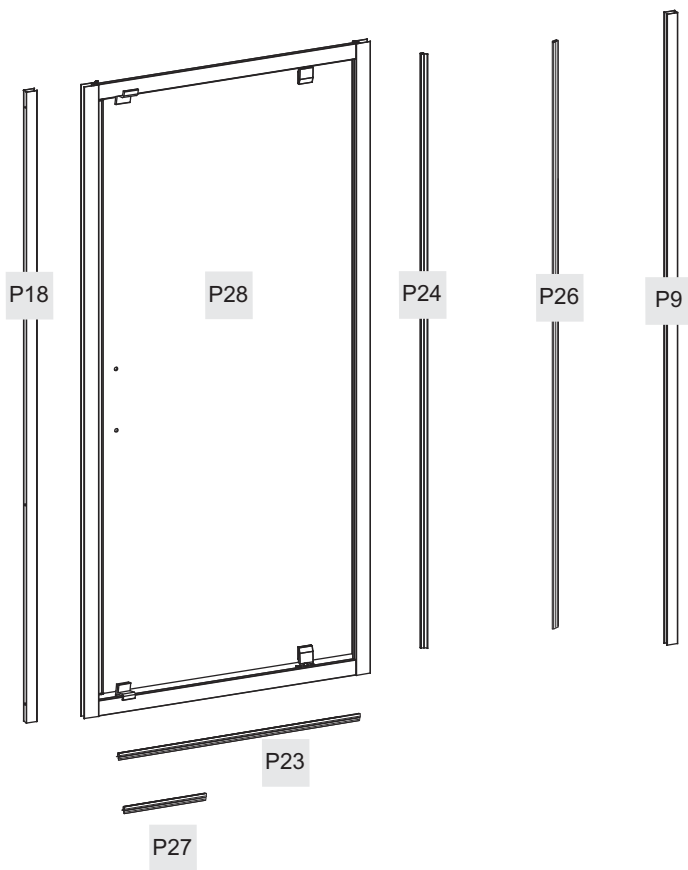

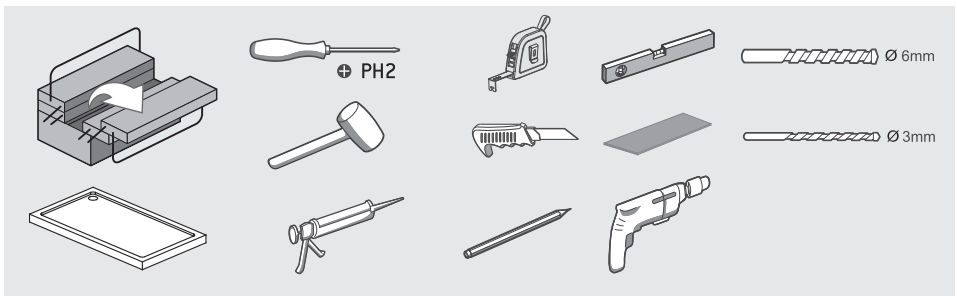
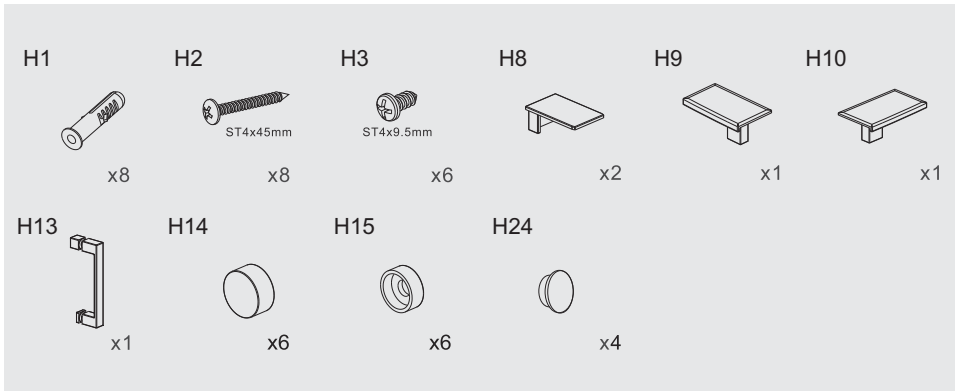

1.

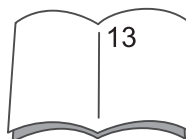
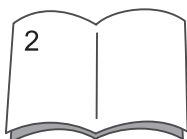
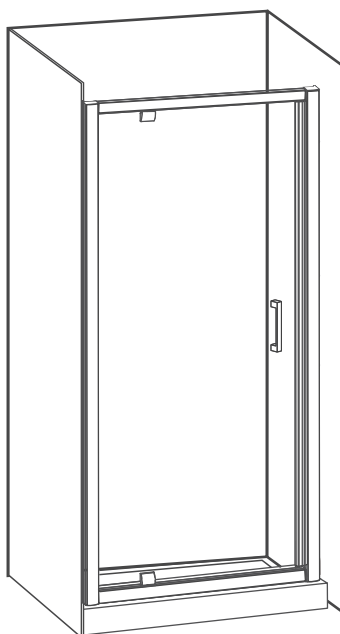
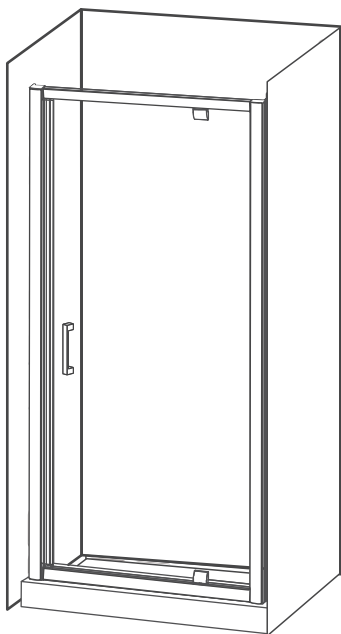

2.



SIZE	X(mm)
700X1850mm	670-700
800X1850mm	770-800
900X1850mm	870-900

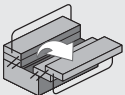
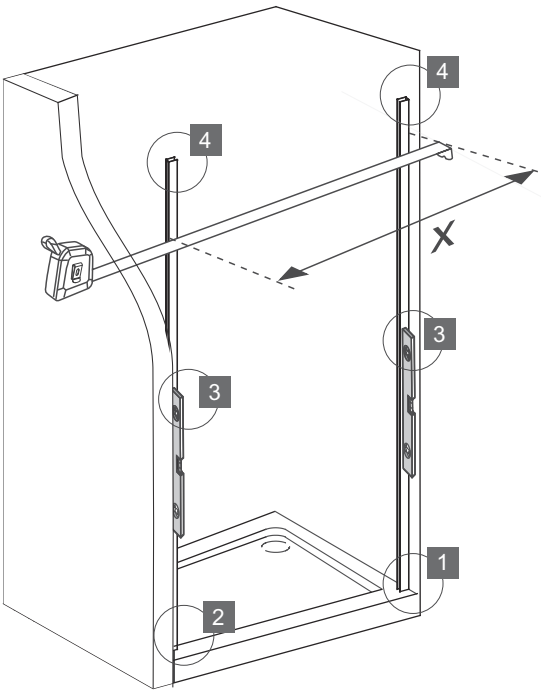
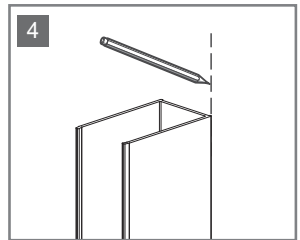
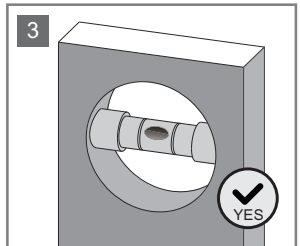
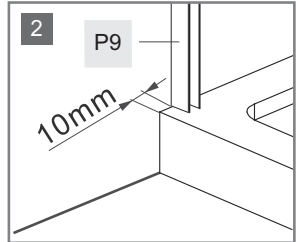
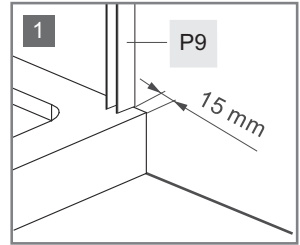

P9  x1



3.

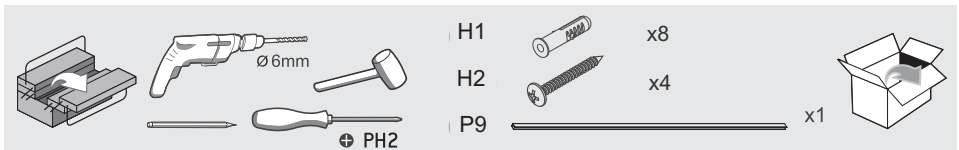
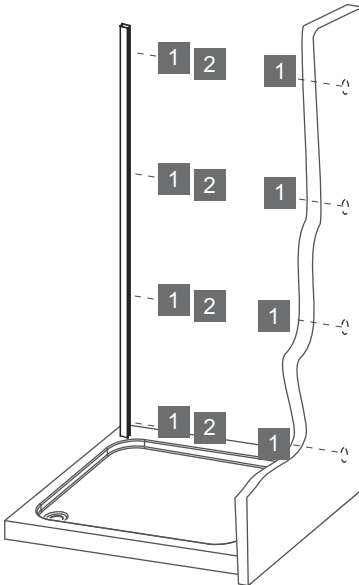
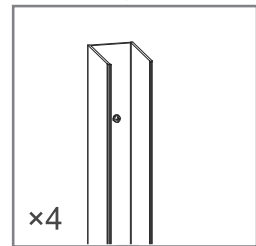
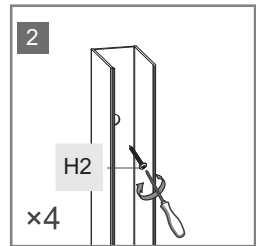
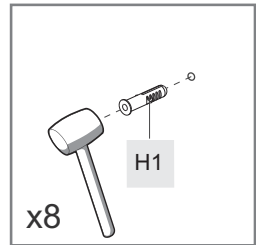
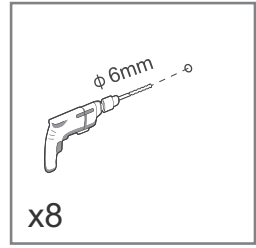
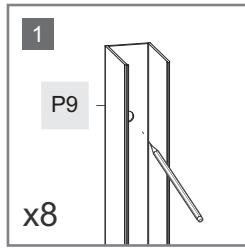
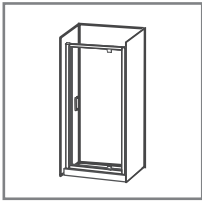

4.

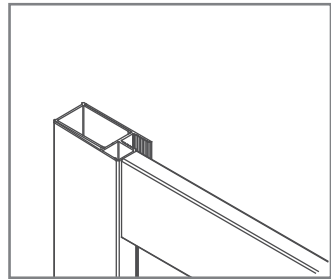
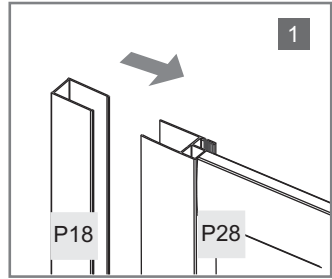
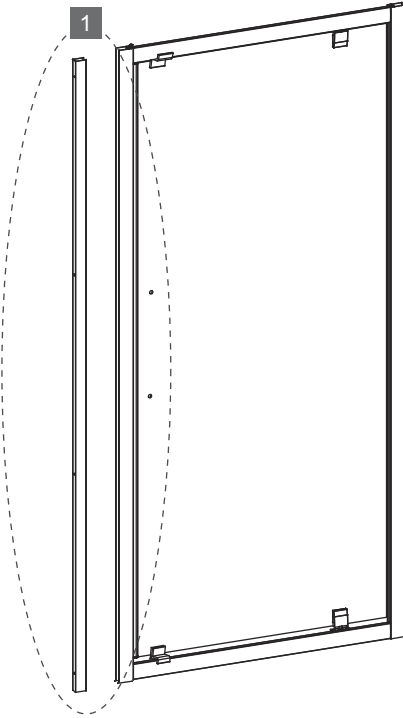
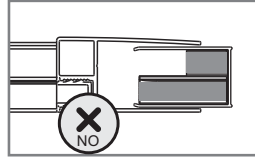
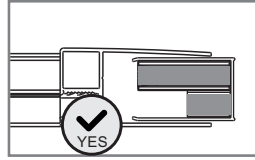

P28



x1

P18



x1



5.

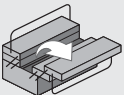
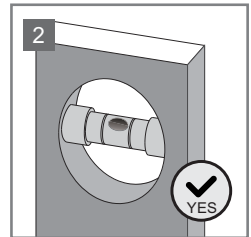
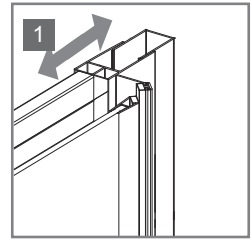
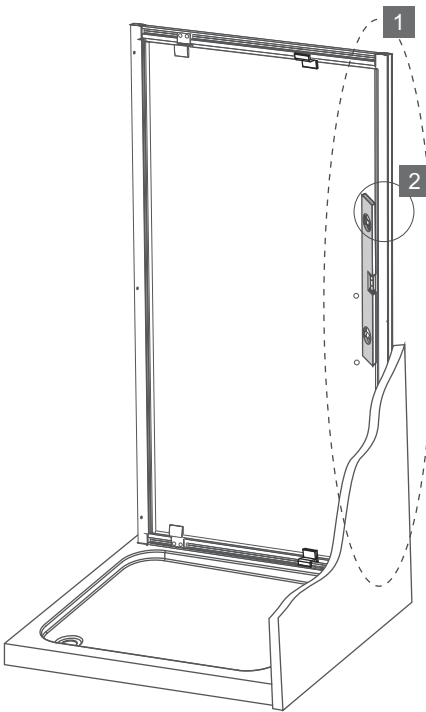
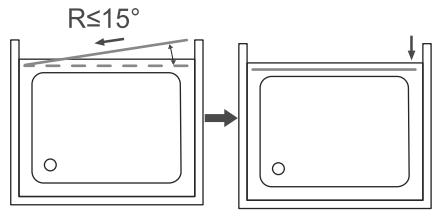
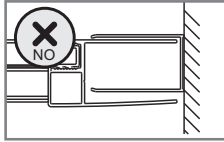
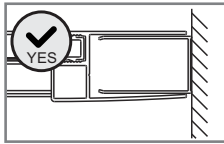
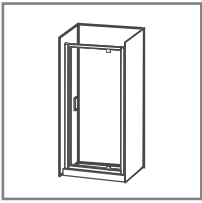

6.

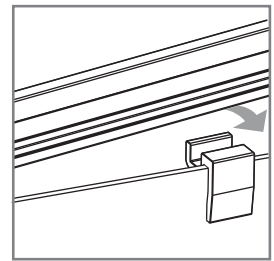
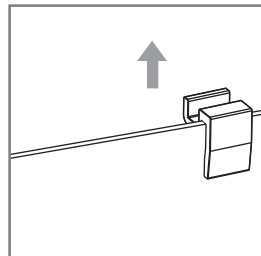
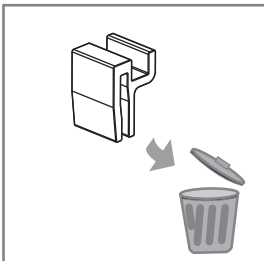
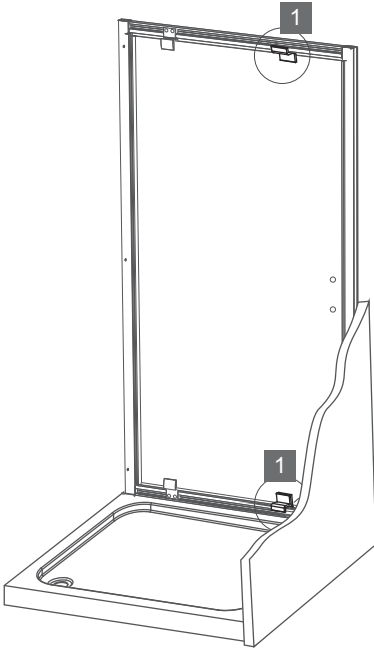
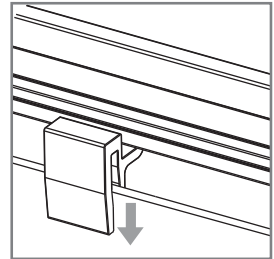
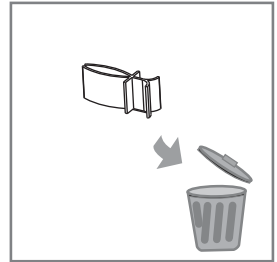
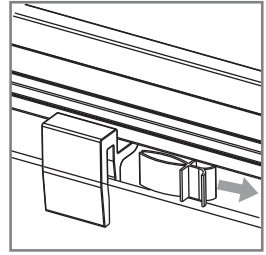
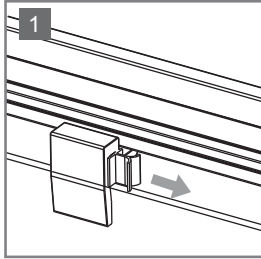

7.

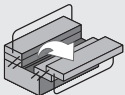
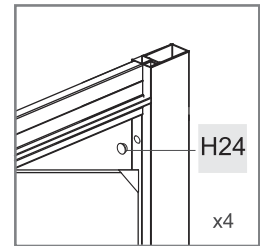
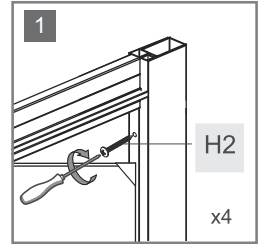
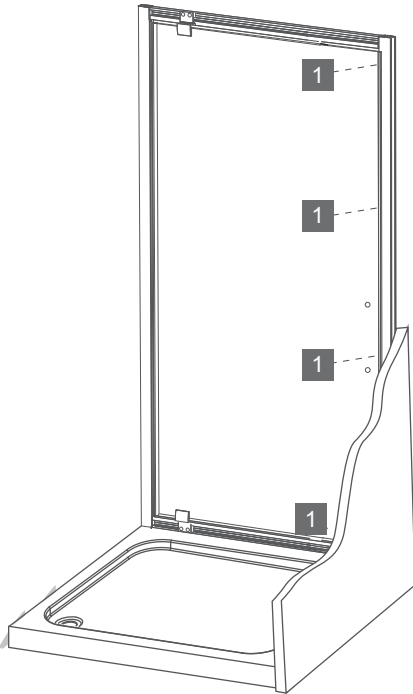
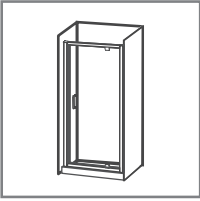

H2  x4

H24  x4



8.

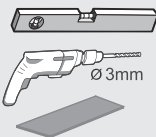
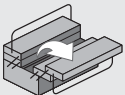
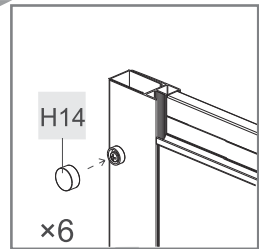
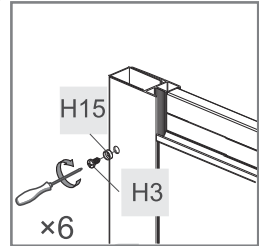
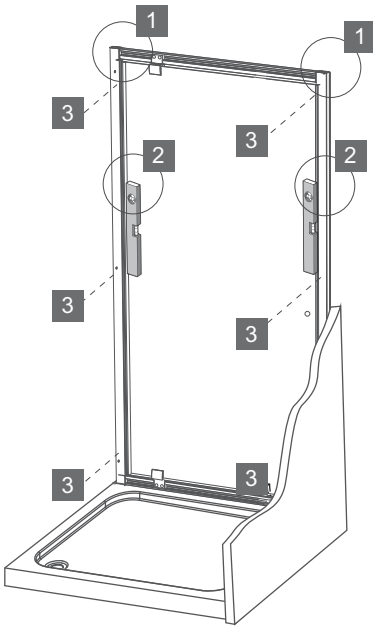
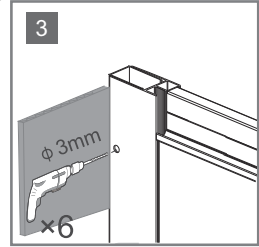
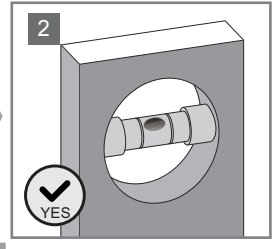
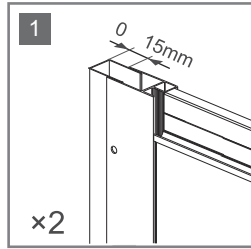
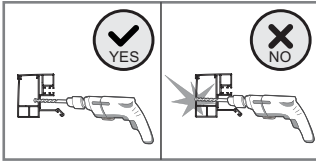

H3

x6

H14

x6

H15

x6



9.

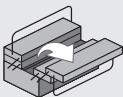
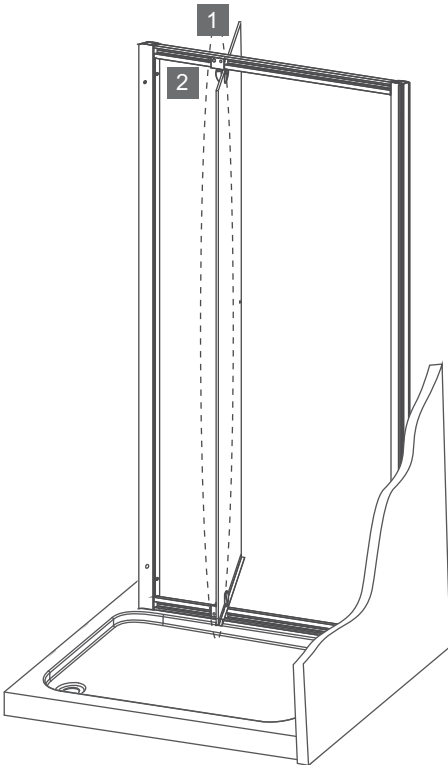
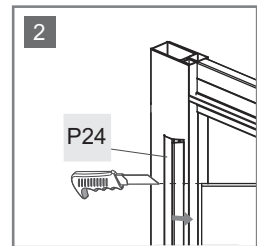
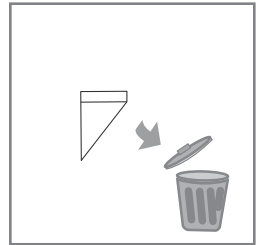
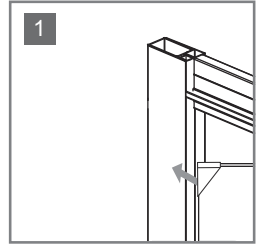

P24



x1



10.

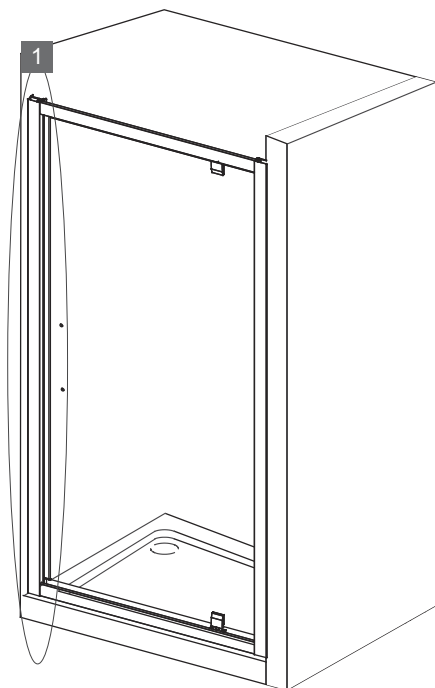
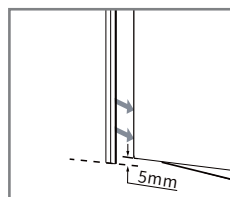
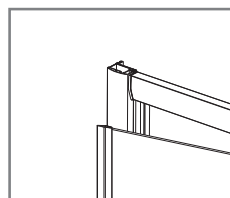
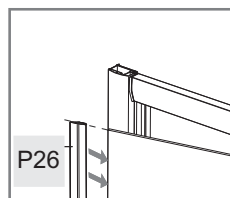
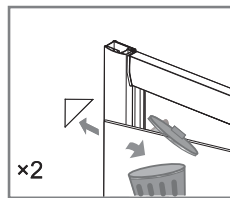
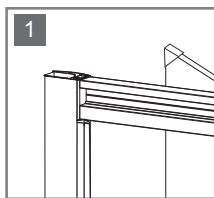
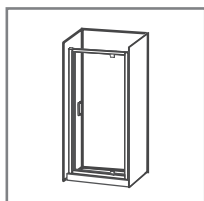

P26



x1



11.

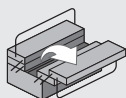
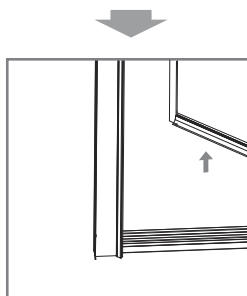
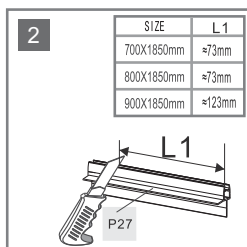
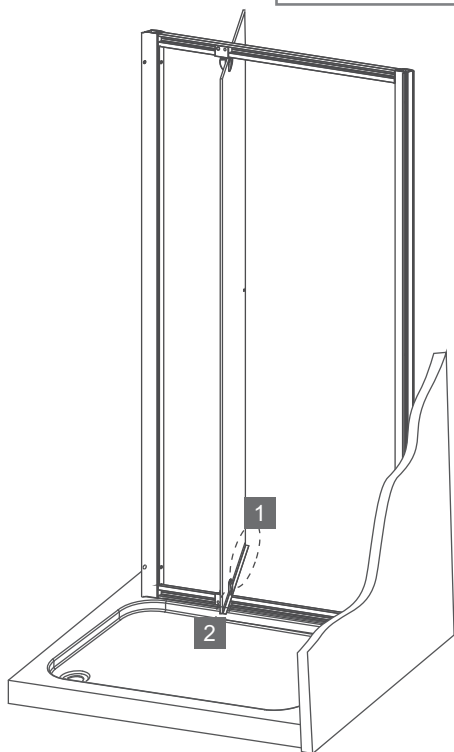
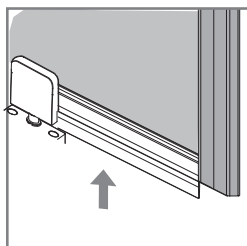
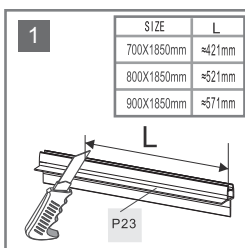
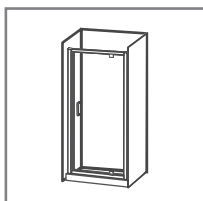

P23  x1

P27  x1



12.

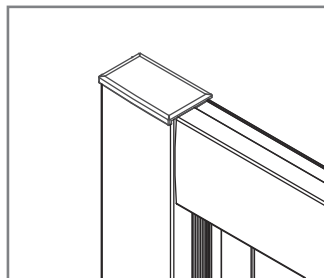
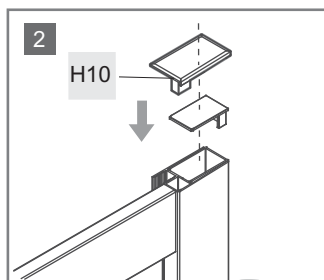
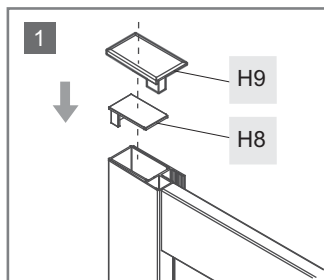
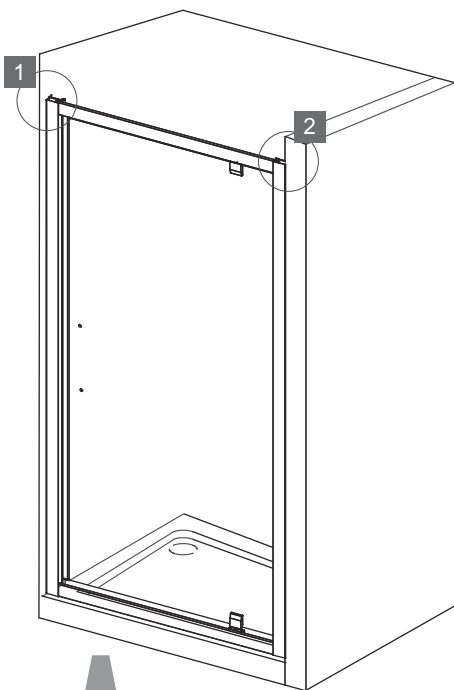
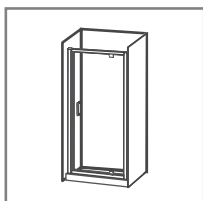

H8



x2

H9



x1

H10



x1



13.

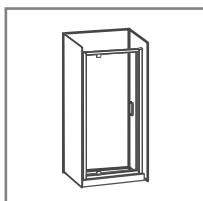

SIZE	X(mm)
700X1850mm	670-700
800X1850mm	770-800
900X1850mm	870-900

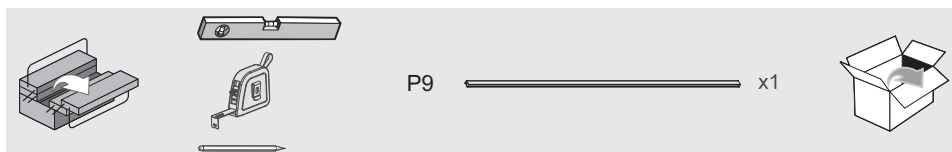
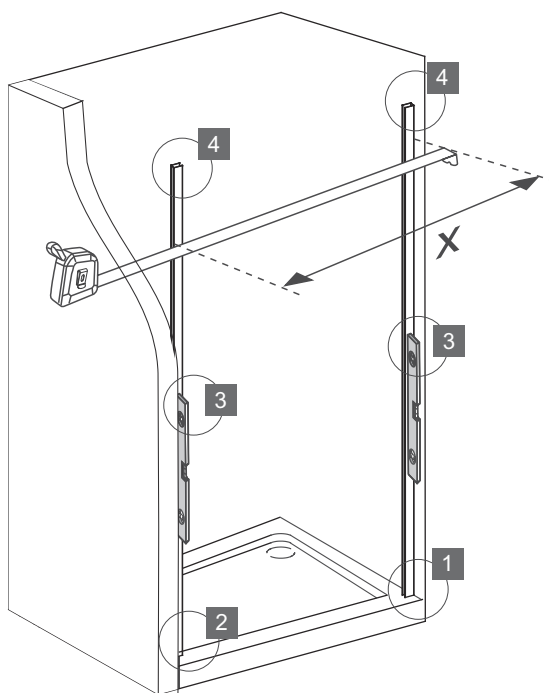
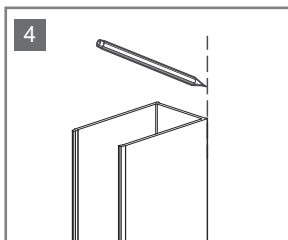
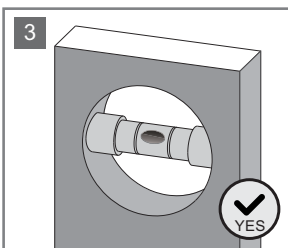
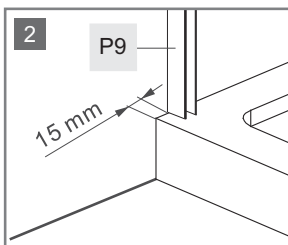
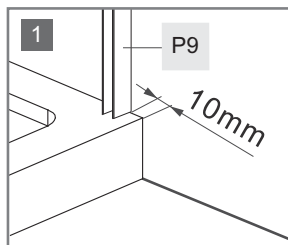

14.

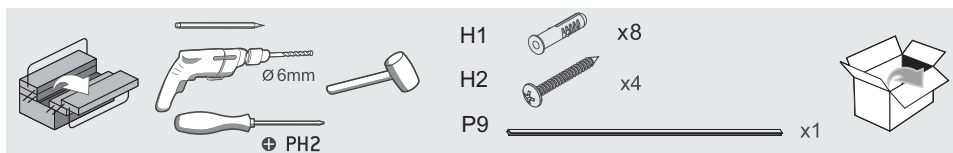
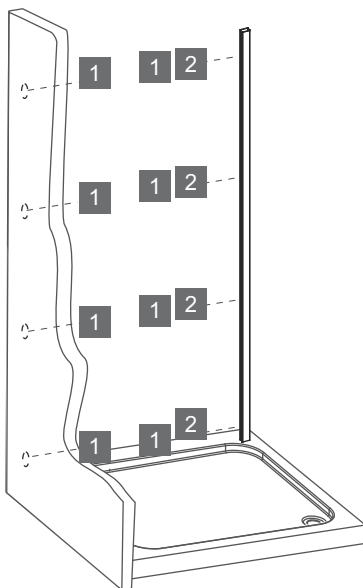
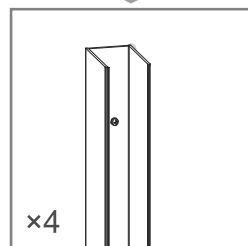
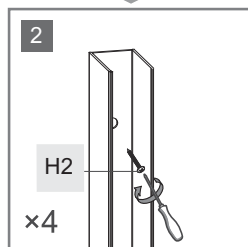
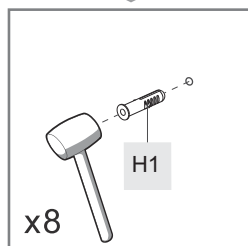
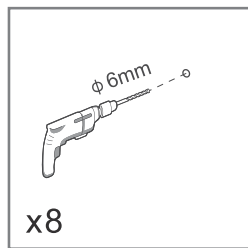
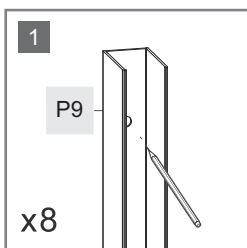
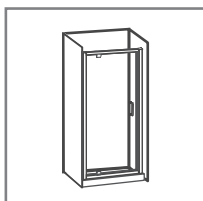

15.

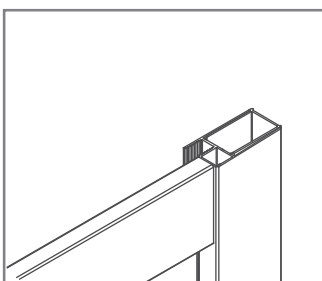
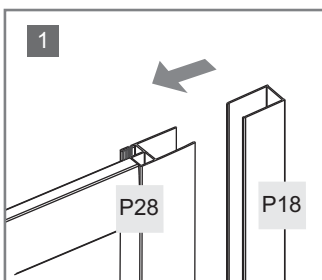
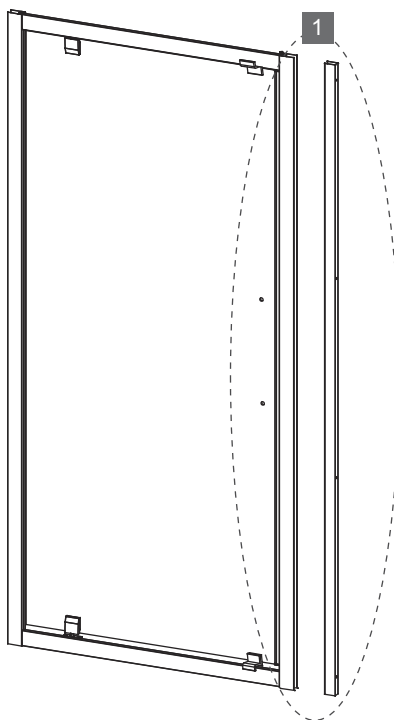
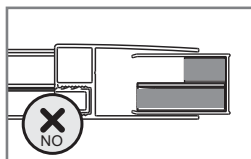
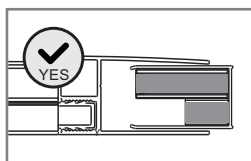
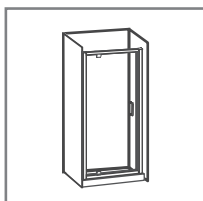

P28

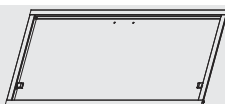

x1

P18



x1



16.

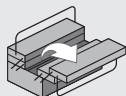
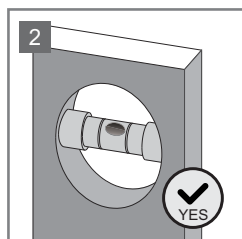
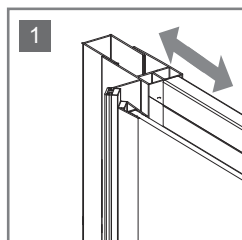
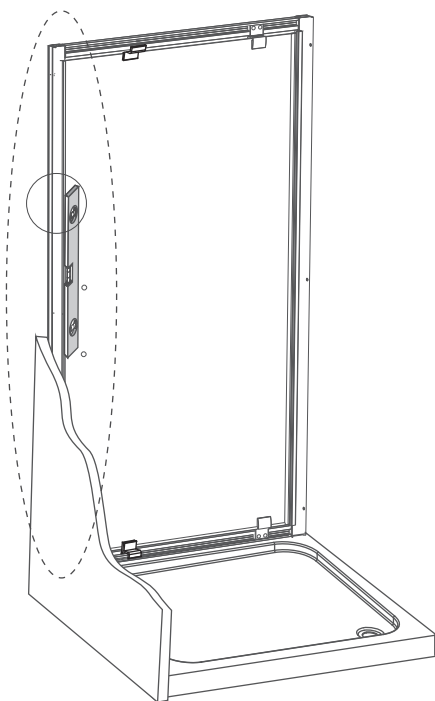
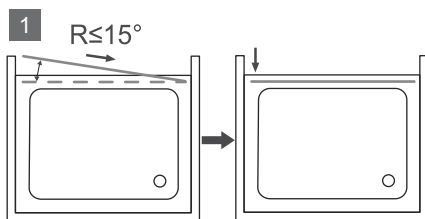
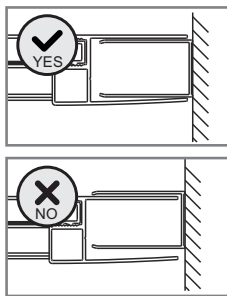
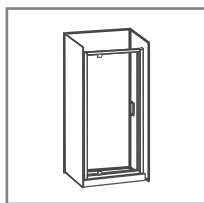

17.

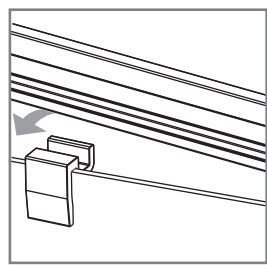
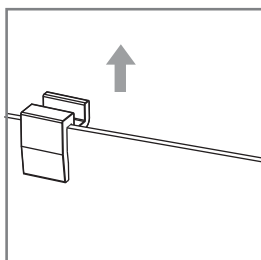
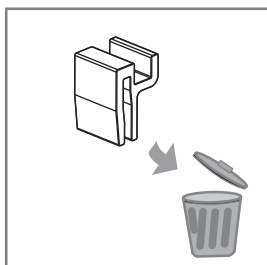
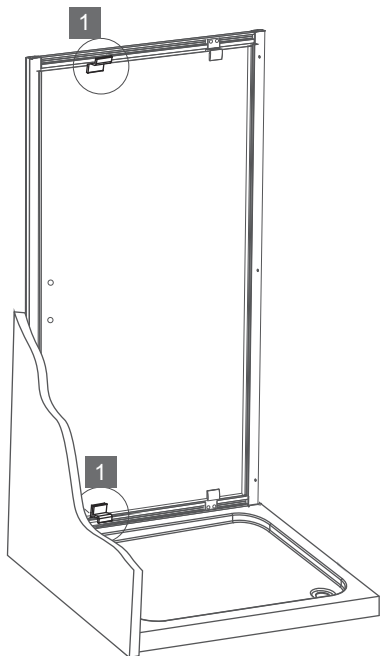
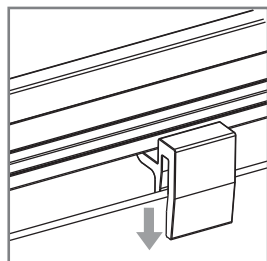
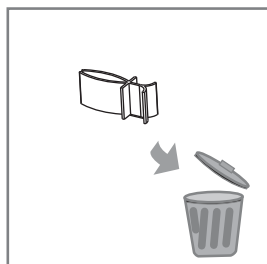
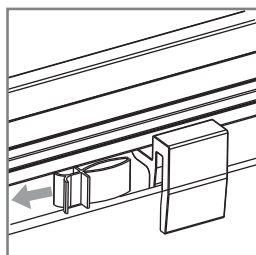
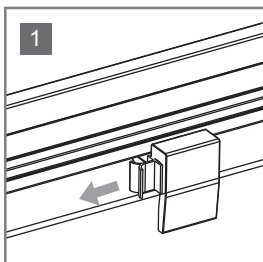
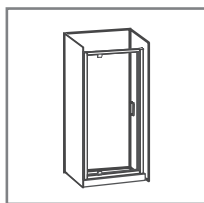

18.

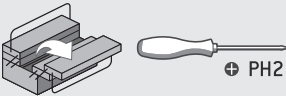
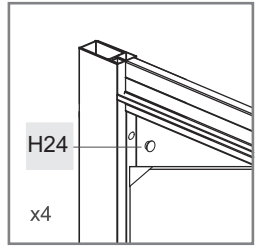
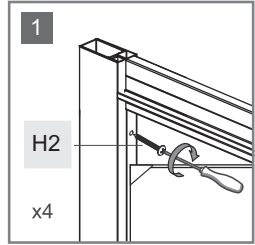
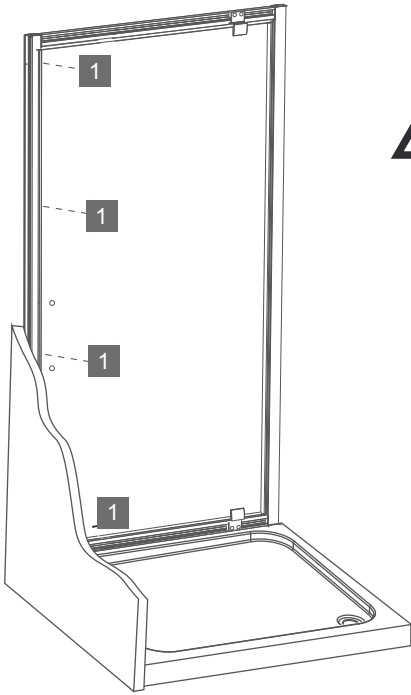

H2  x4

H24  x4



19.

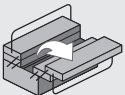
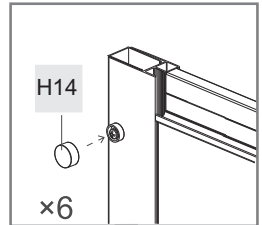
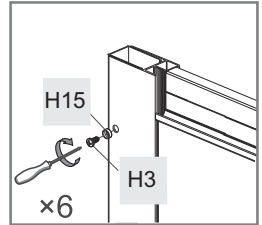
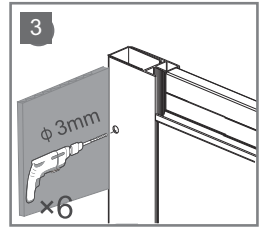
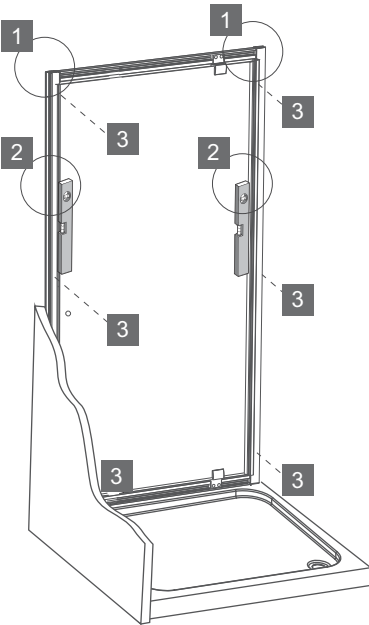
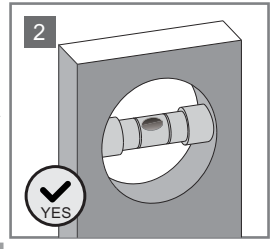
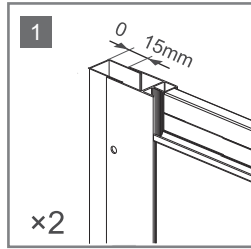
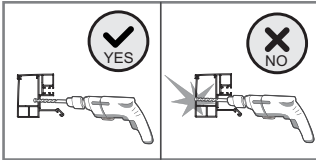
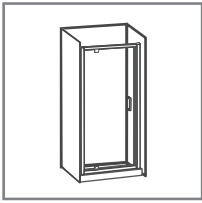

H3  x6

H14  x6

H15  x6



20.

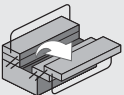
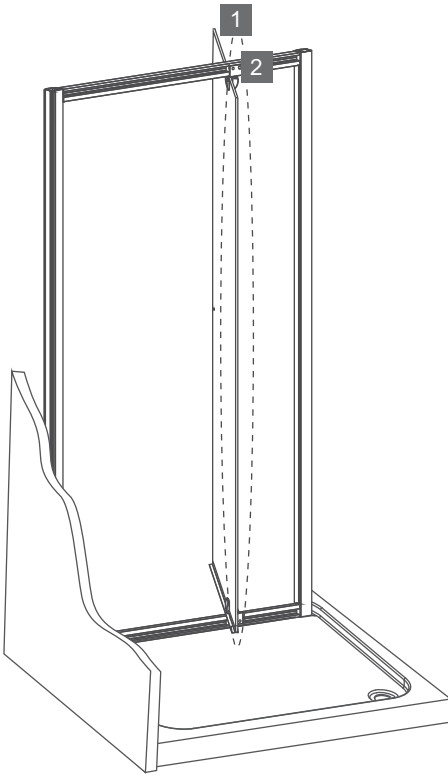
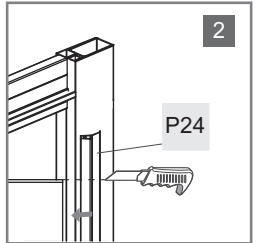
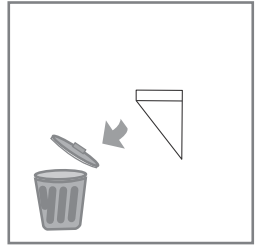
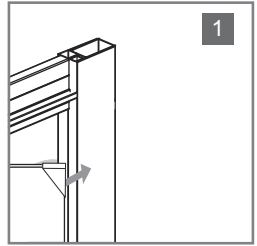

P24 ←—————→ x1



21.

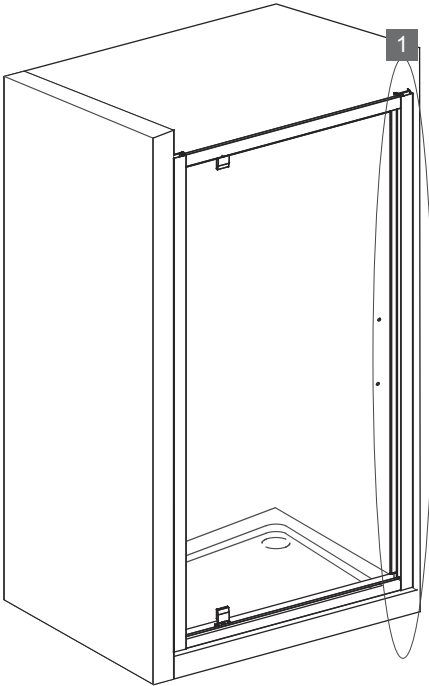
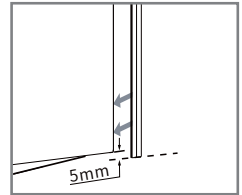
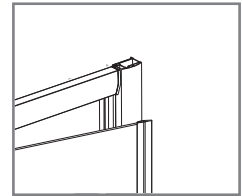
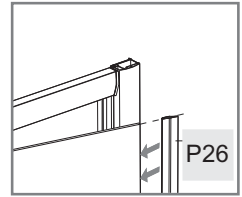
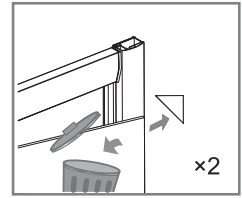
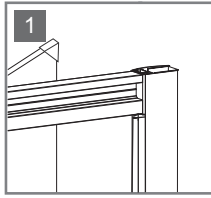

P26



x1



22.



1

SIZE	L
700X1850mm	≈421mm
800X1850mm	≈521mm
900X1850mm	≈571mm

P23

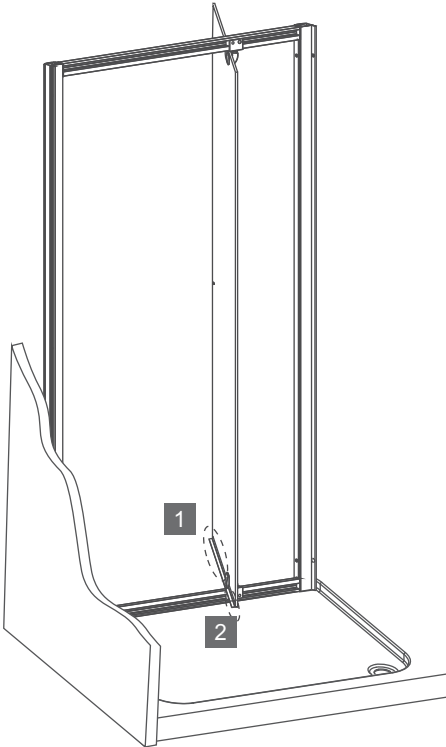
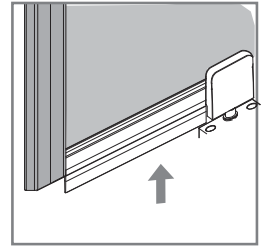

2

SIZE	L 1
700X1850mm	≈73mm
800X1850mm	≈73mm
900X1850mm	≈123mm

P27

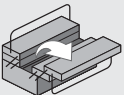
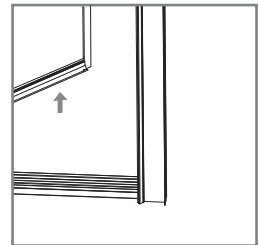

P23



x1

P27



x1



23.

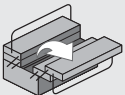
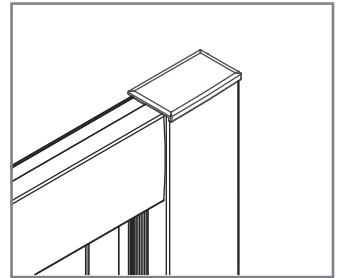
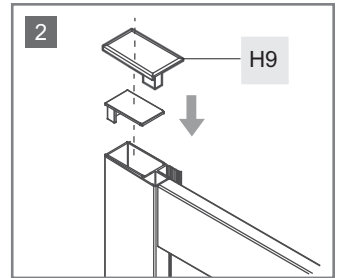
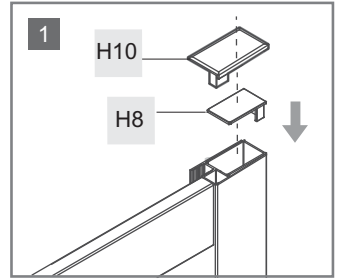
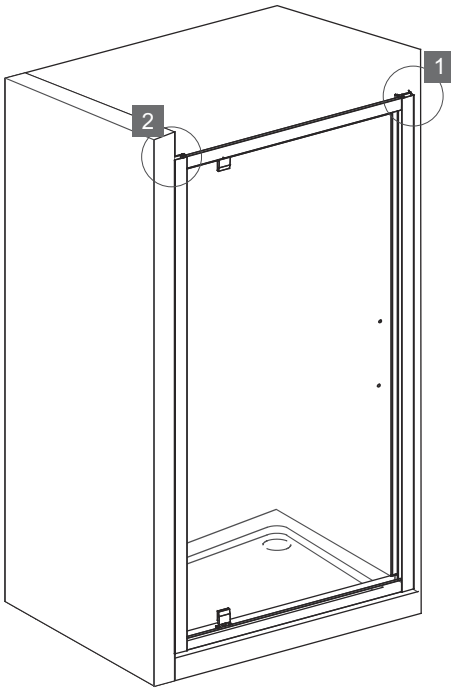

H8



x2

H9



x1

H10



x1



24.

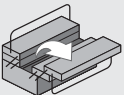
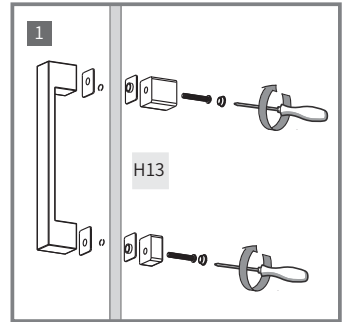
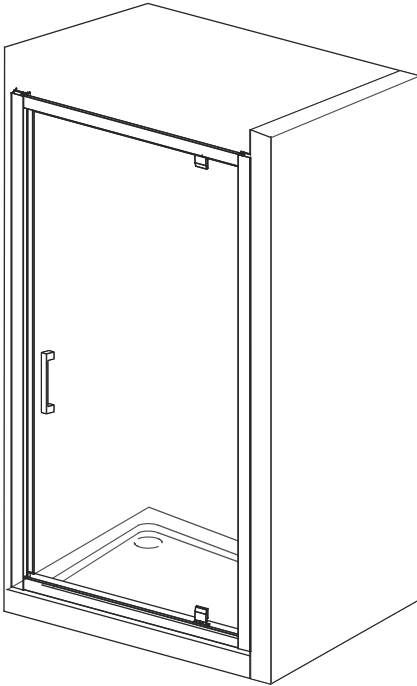

H13



x1



25.

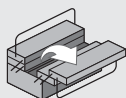
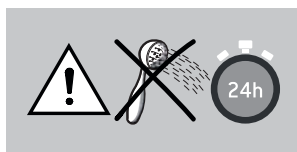
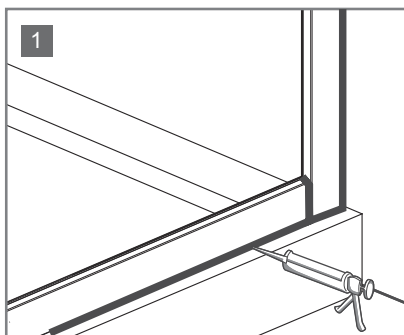
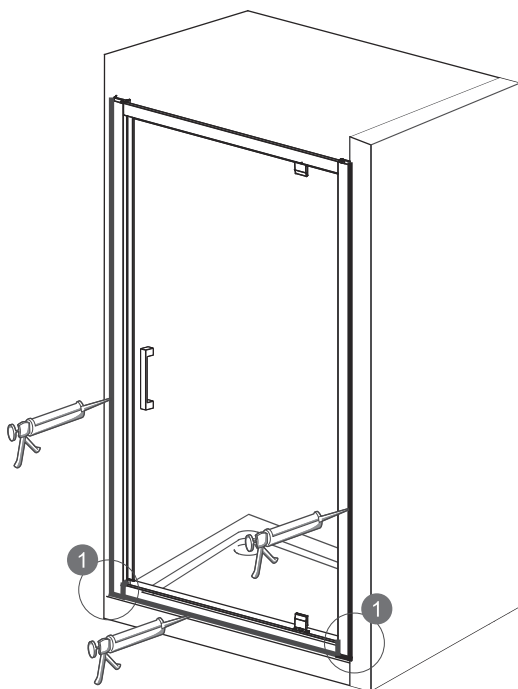
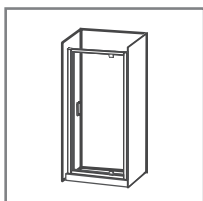



6.5 < PH < 7.5

