

# Moduo

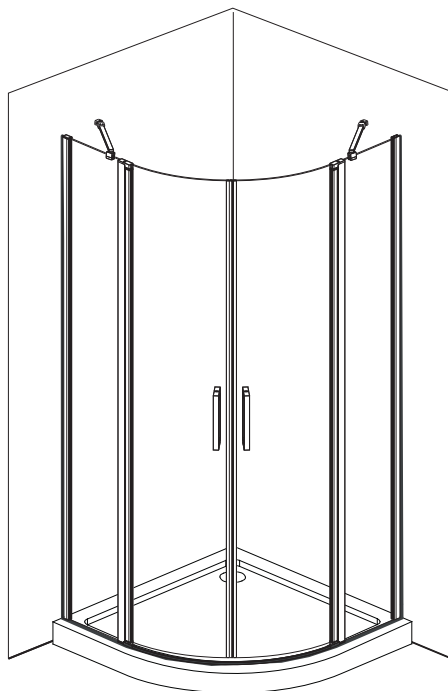

PL INSTRUKCJA MONTAŻU I EKSPLOATACJI

CZ NÁVOD NA MONTÁŽ A ÚDRŽBU

SK NÁVOD NA MONTÁŽ A ÚDRŽBU

EST PAIGALDUS- JA KASUTUSJUHEND

LT MONTAVIMO IR EKSPLOATAVIMO INSTRUKCIJA

LV MONTĀŽAS UN EKSPLUATĀCIJAS INSTRUKCIJA

DE MONTAGE- UND AUFBAUANLEITUNG

RO INSTRUCȚIUNI DE MONTAJ ȘI OPERARE

HU SZERELÉSI ÉS ÜZEMELTETÉSI ÚTMUTATÓ

UA ІНСТРУКЦІЯ З МОНТАЖУ І ЕКСПЛУАТАЦІЇ

BY ІНСТРУКЦЫЯ ПА МАНТАЖЫ І ЭКСПЛУАТАЦЫІ

RU ИНСТРУКЦИЯ ПО МОНТАЖУ И ЭКСПЛУАТАЦИИ





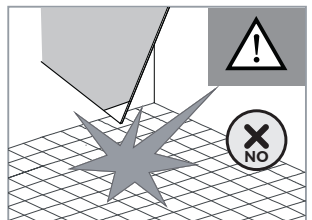
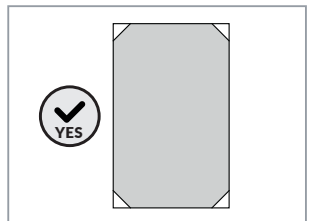
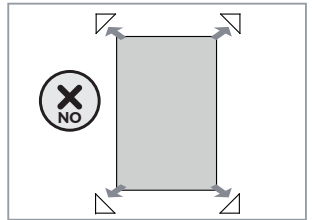
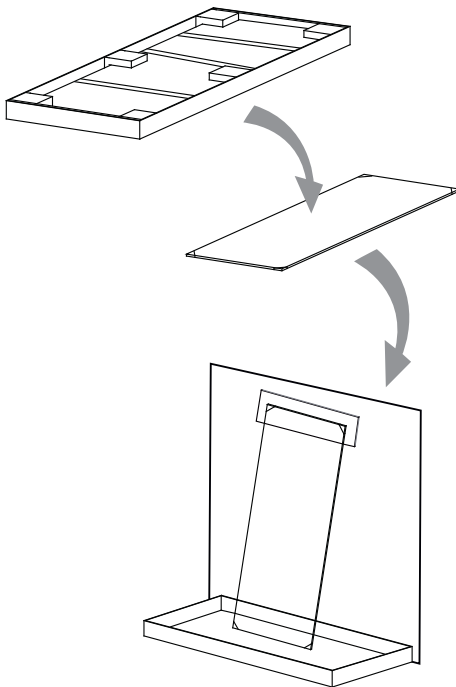
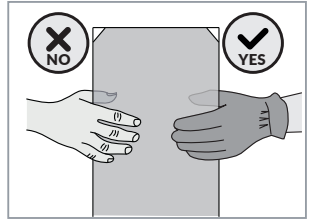
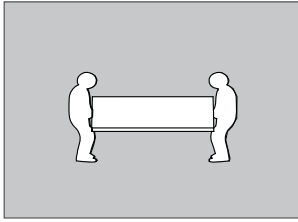
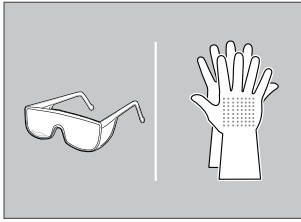
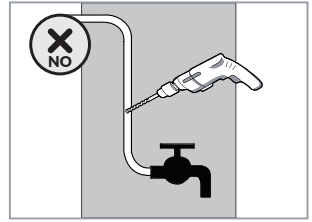
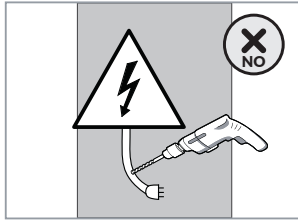
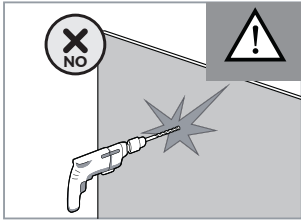

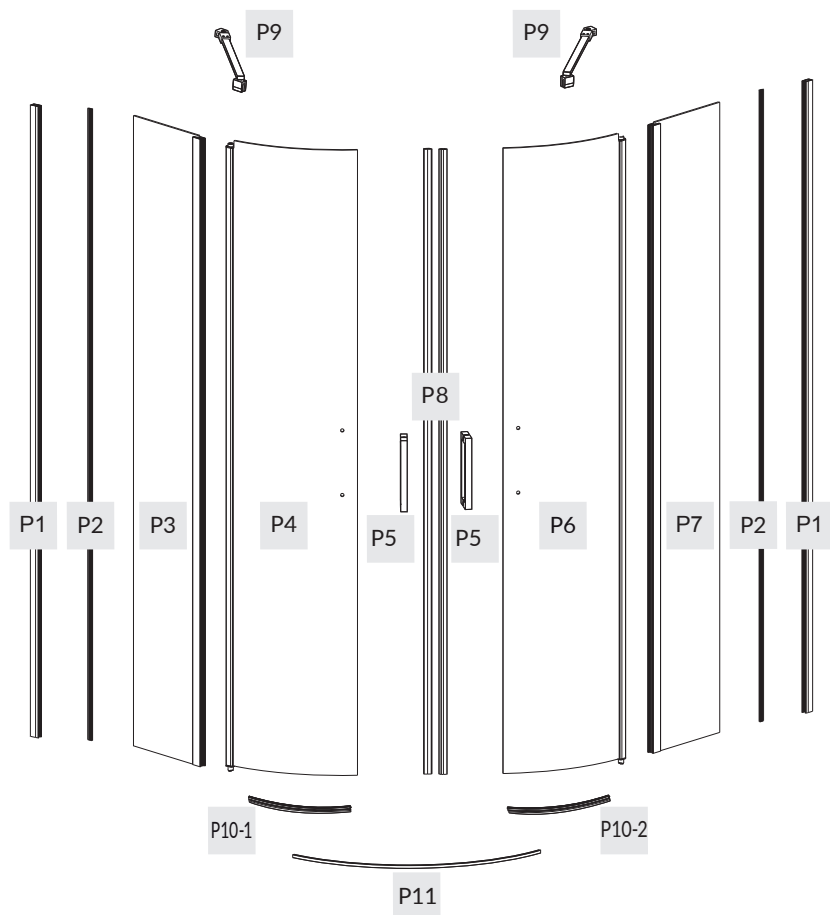
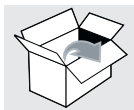

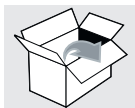

EN INSTRUCTIONS FOR ASSEMBLY AND USE

FR INSTALLATION ET UTILISATION - MODE

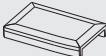
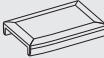

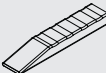



- A  x8  
4X35
- B  x8
- C  x4
- D  x8
- E  x4  
3.5X20
- M1  x1
- M2  x1
- G1  x1
- G2  x1
- H  x1
- F1  x4  
1mm
- F2  x4  
2mm
- F3  x4  
3mm

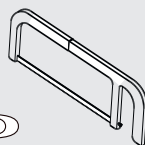
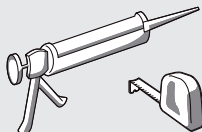
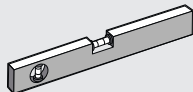
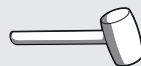
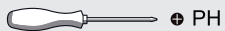
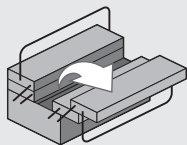

# 1.

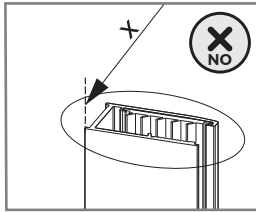
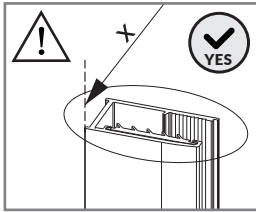

SIZE (mm)	X (mm)
800x800	790~800
900x900	890~900

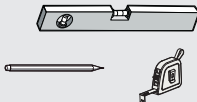
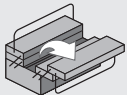
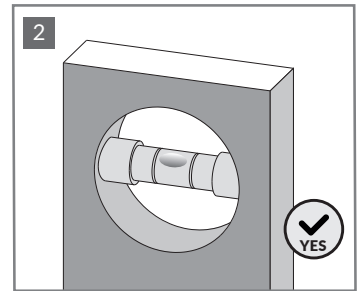
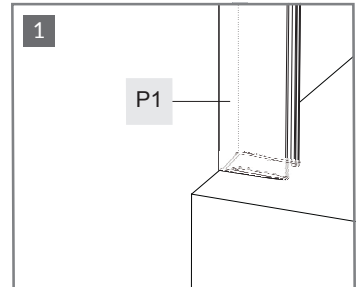
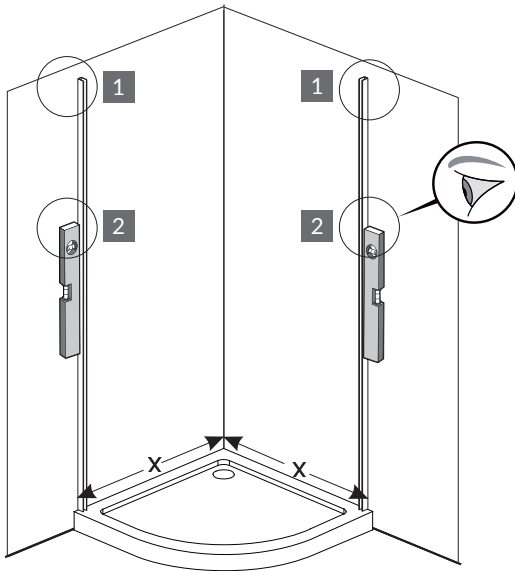

P1



x2



# 2.

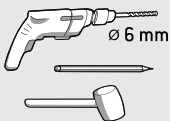
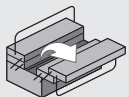
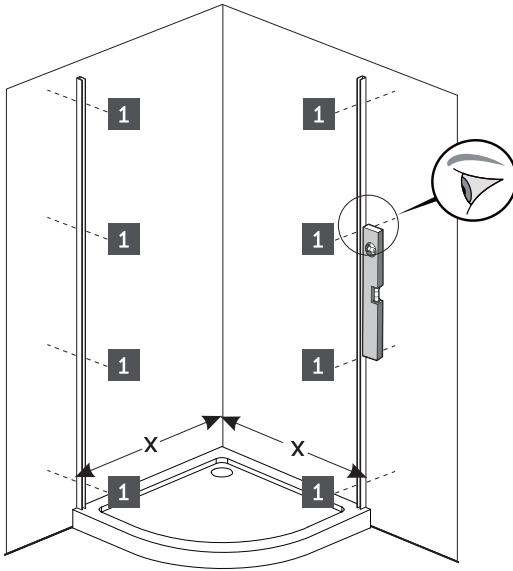
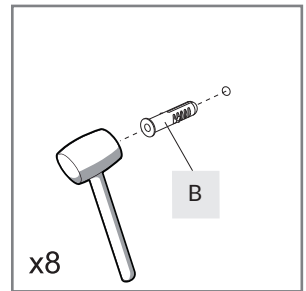
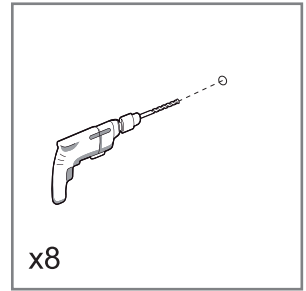
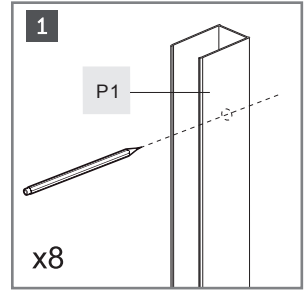
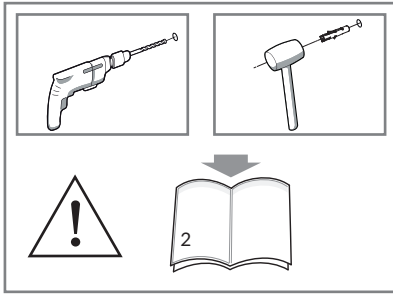

P1

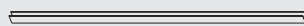

x2

B



x8



3.

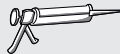
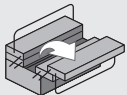
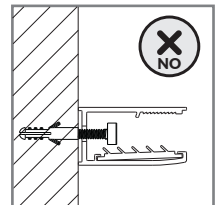
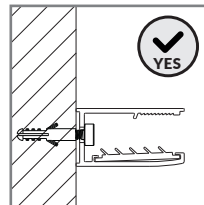
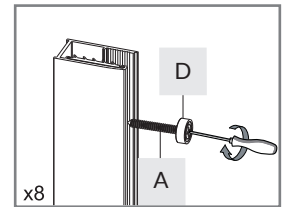
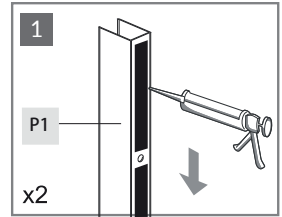
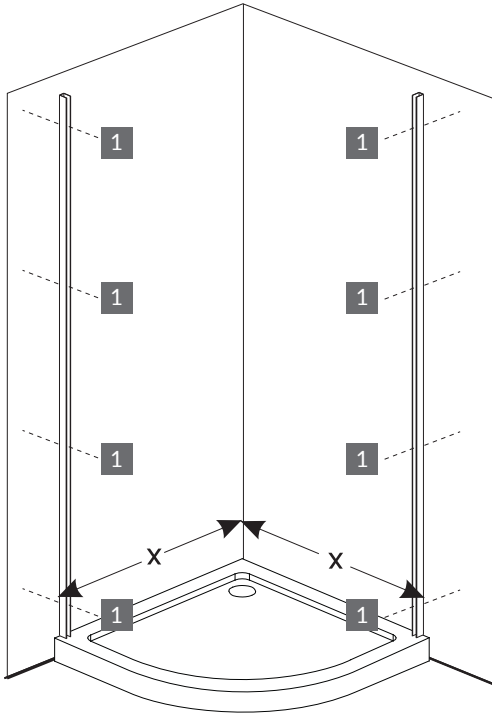

P1



x2

D



x8

A



x8



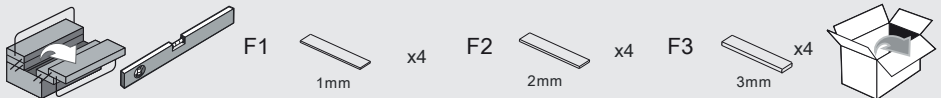
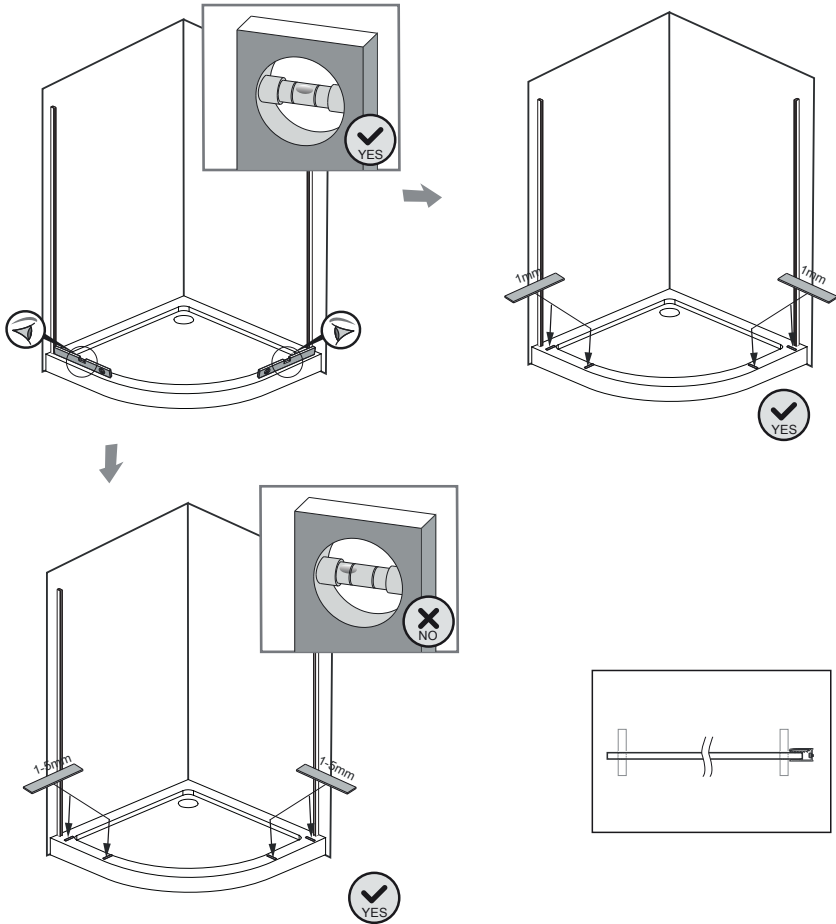

4.



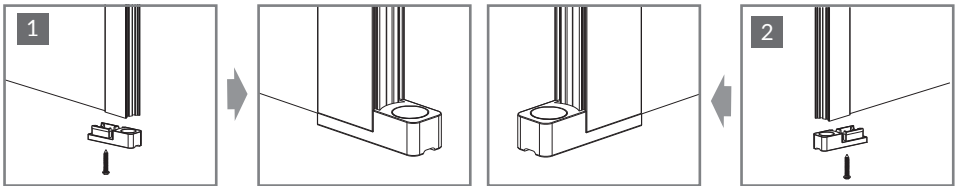
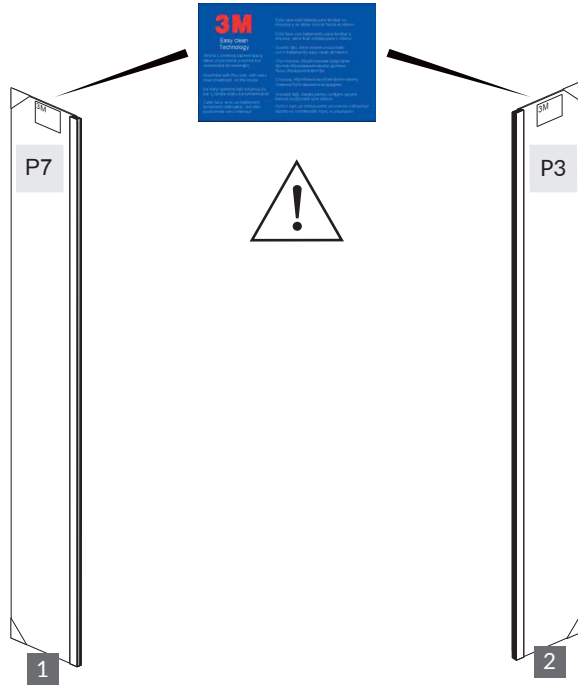

5.

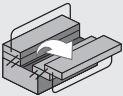
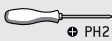
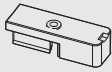
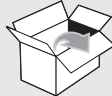

		C		x2	
		E		x2	

# 6.

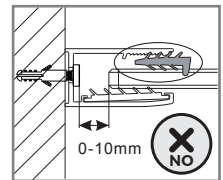
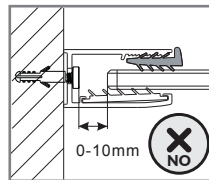
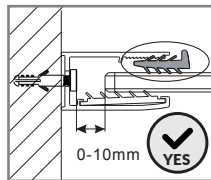
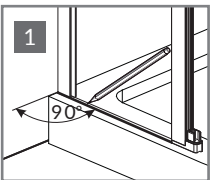
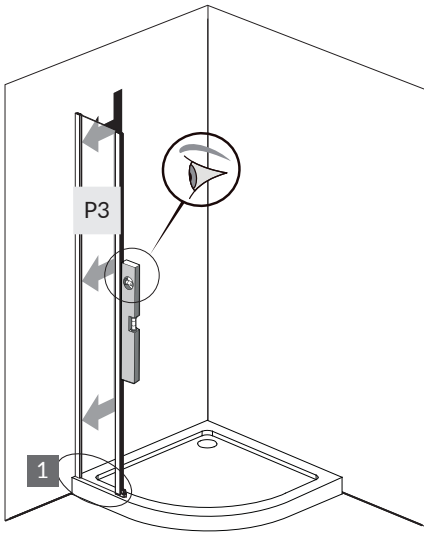
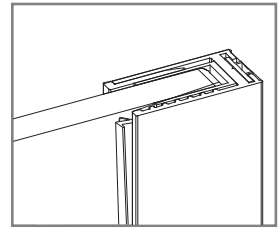
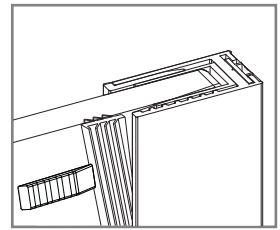
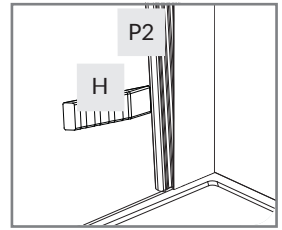
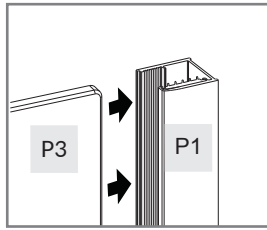
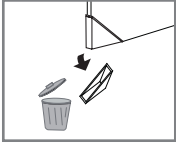
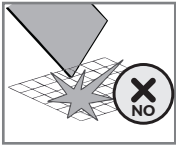

# 7.

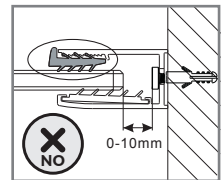
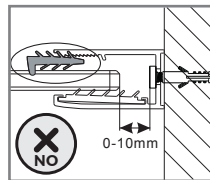
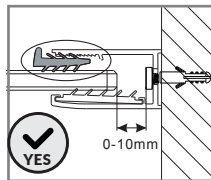
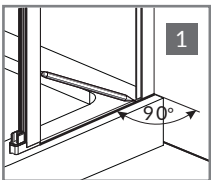
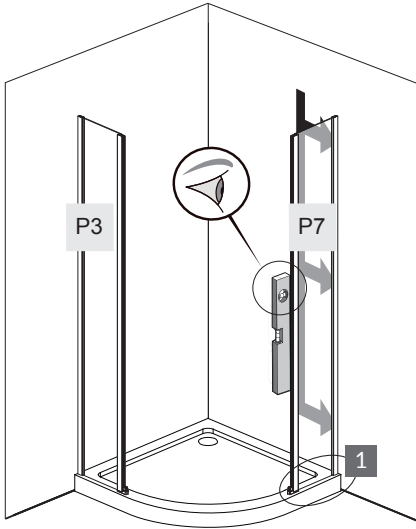
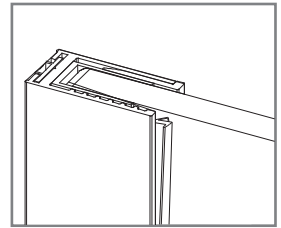
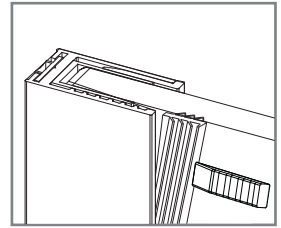
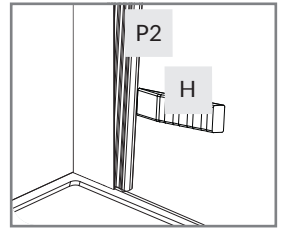
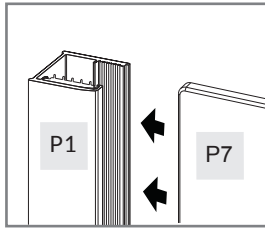
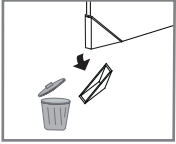
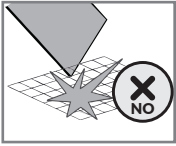

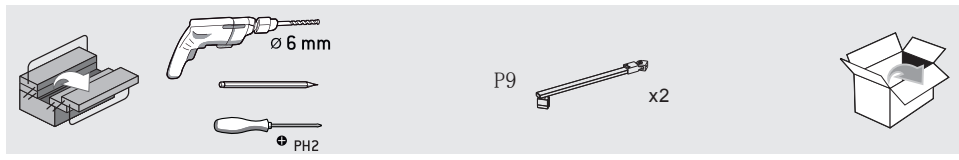
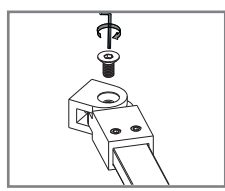
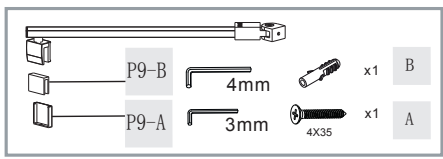
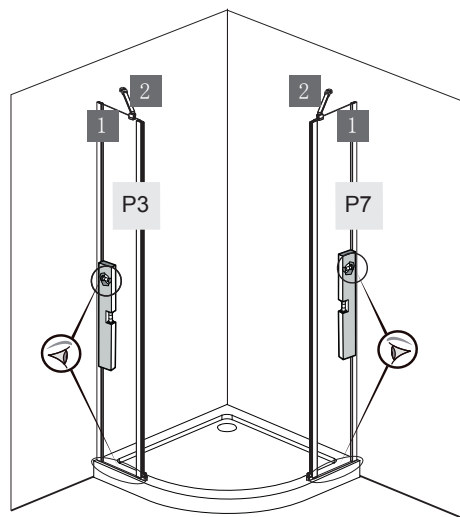
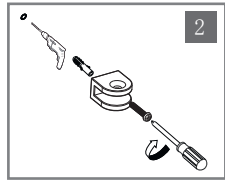
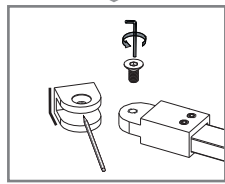
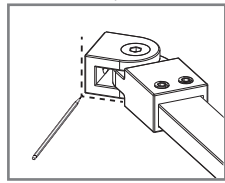
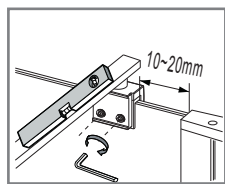
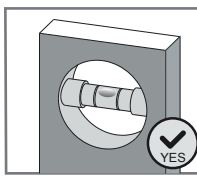
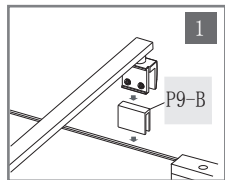
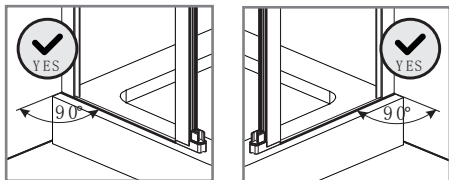

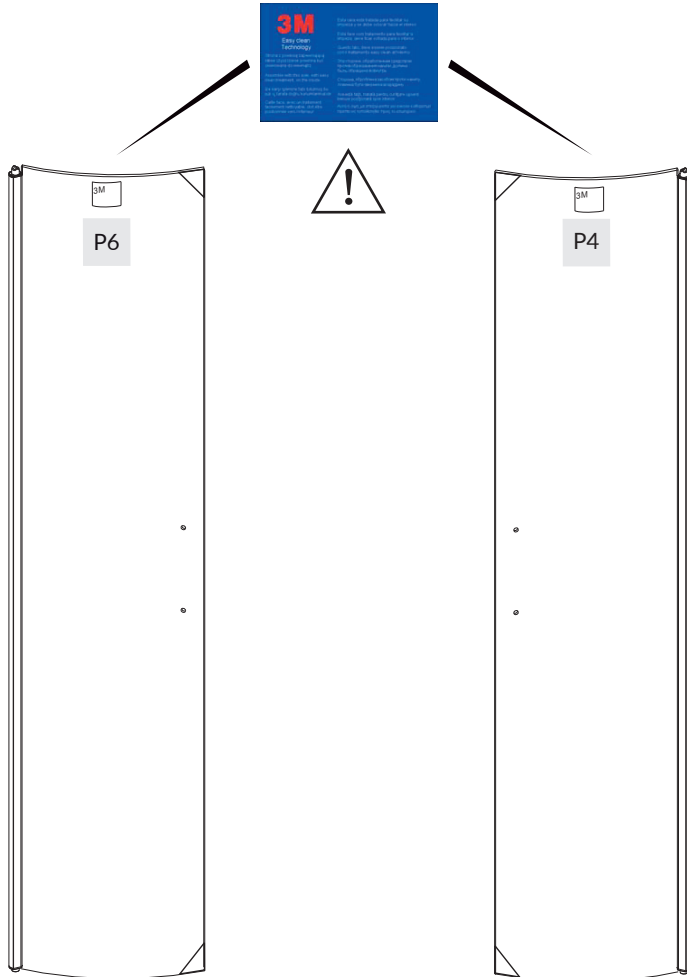

10.

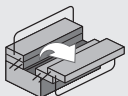
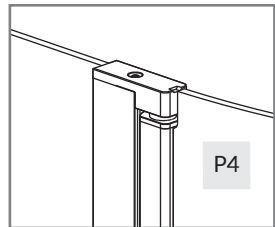
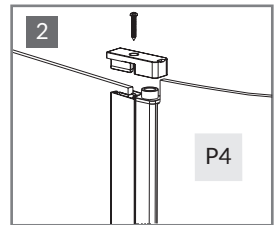
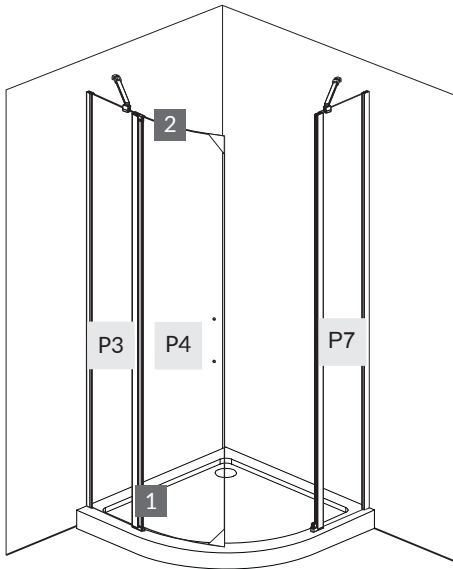
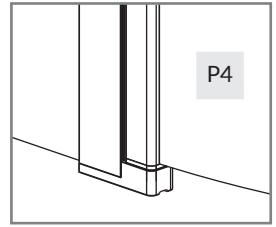
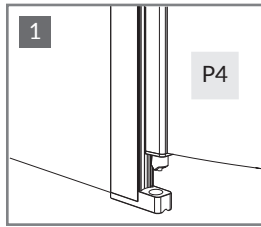
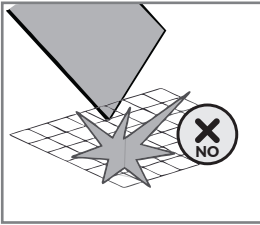

C

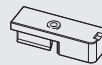

x1

E



x1



# 11.

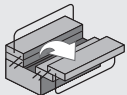
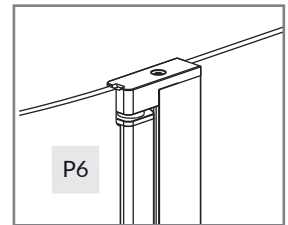
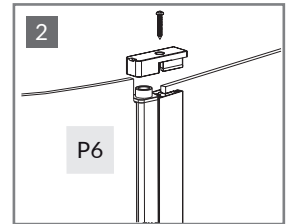
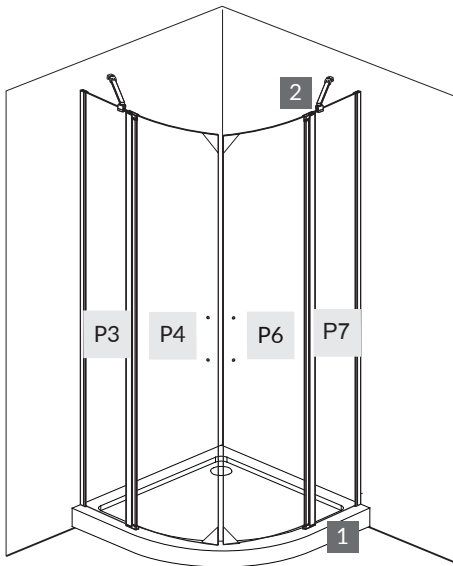
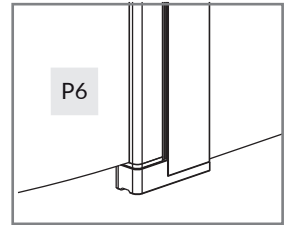
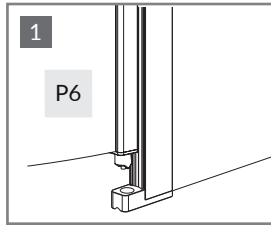
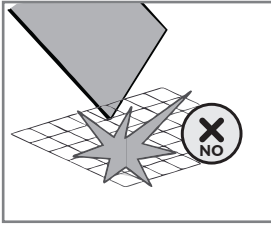

C

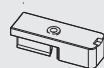

x1

E



x1



12.

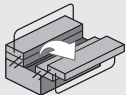
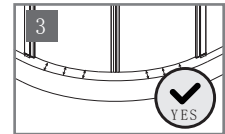
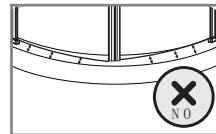
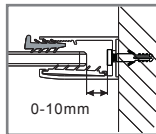
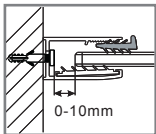
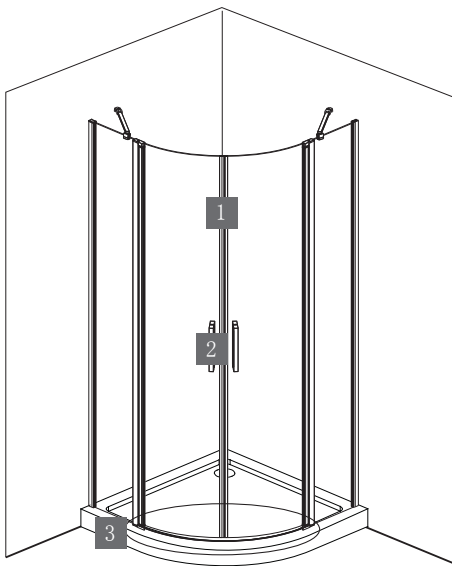
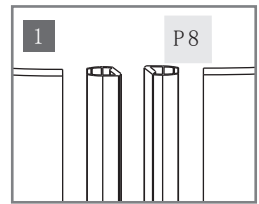
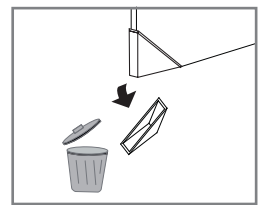
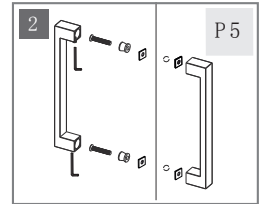
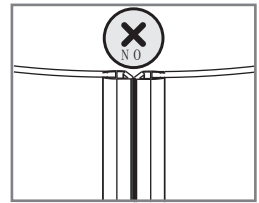
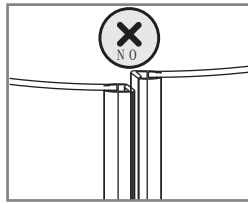
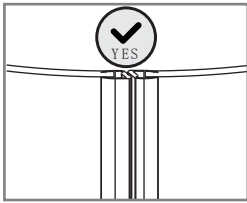

P8 ————— x2

P5 ———— x2





13.

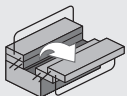
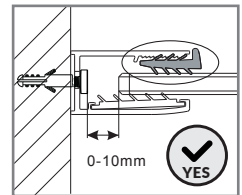
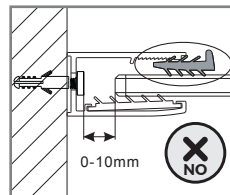
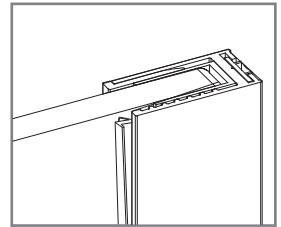
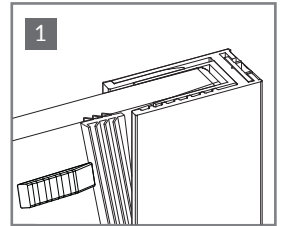
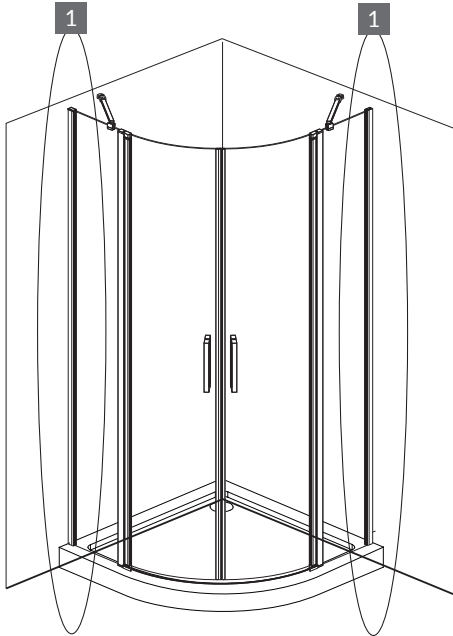
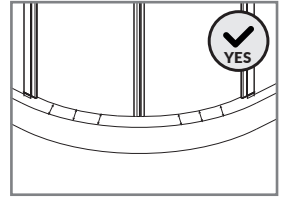
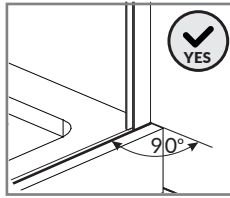
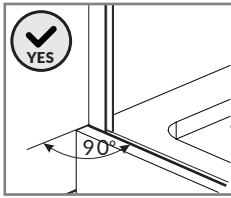

H



x1



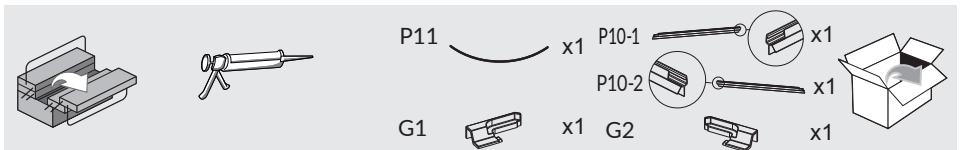
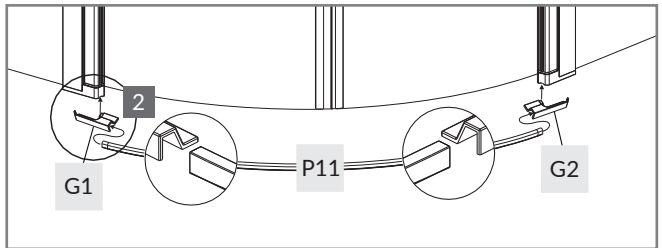
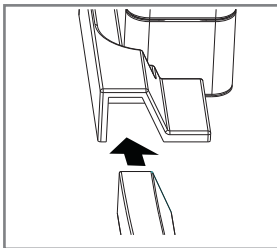
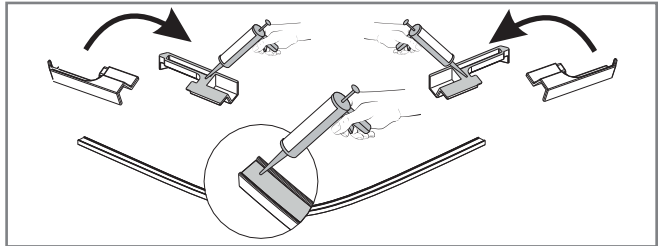
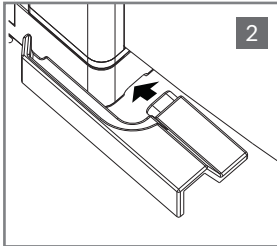
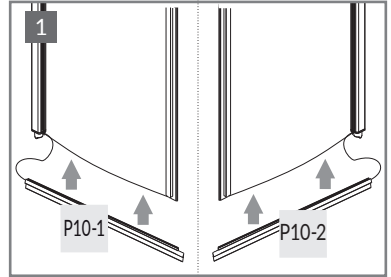
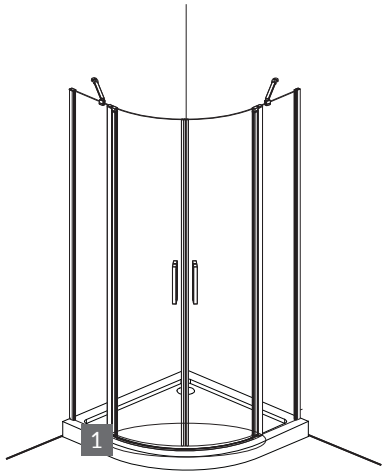

15.

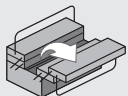
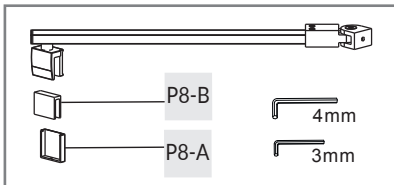
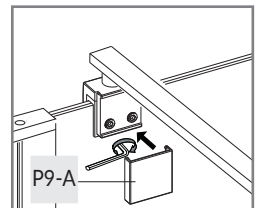
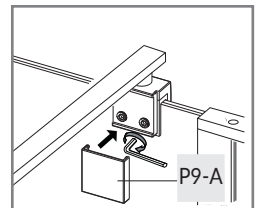
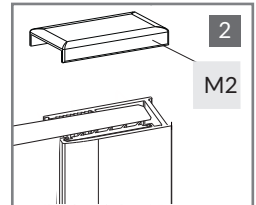
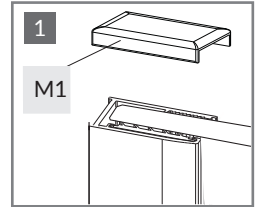
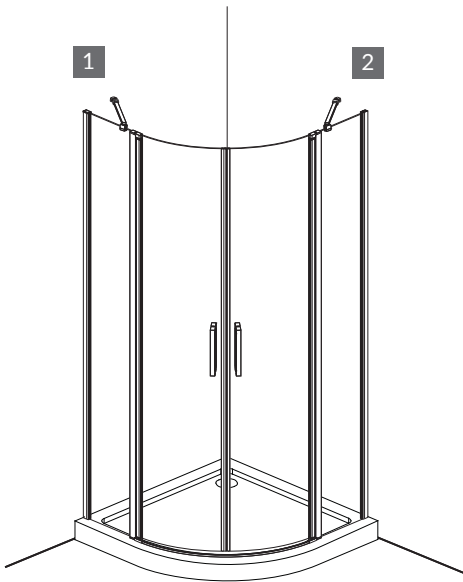
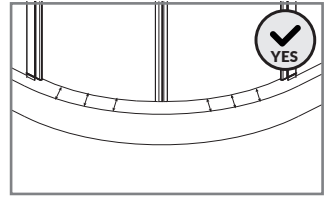
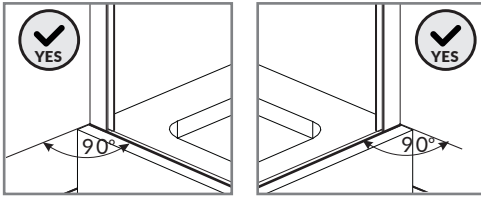

P9  x2

M1  x1

M2  x1



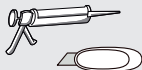
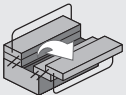
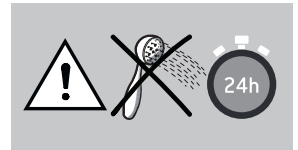
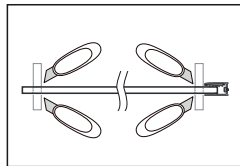
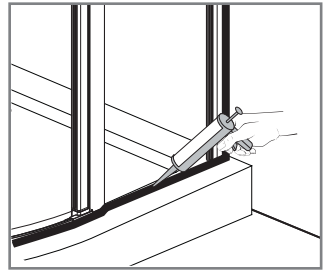
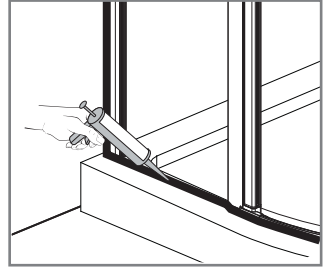
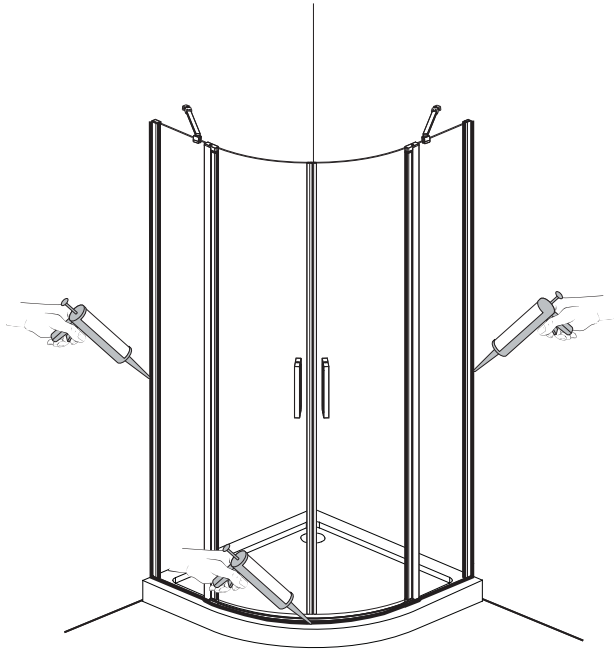



6.5 < PH < 7.5

